



**TURKEY'S  
EFFECTIVE FIGHT  
AGAINST  
CORONAVIRUS**





**TURKEY'S  
EFFECTIVE FIGHT  
AGAINST CORONAVIRUS**

**TURKEY'S  
EFFECTIVE FIGHT  
AGAINST CORONAVIRUS**



ISBN: 978-605-06504-1-9

**TURKEY'S EFFECTIVE FIGHT AGAINST CORONAVIRUS**

**PRESIDENCY OF THE REPUBLIC OF TURKEY DIRECTORATE OF COMMUNICATIONS**



**PUBLICATIONS BY PRESIDENCY'S DIRECTORATE OF COMMUNICATIONS**

Yayıncı Sertifika No: 45482

1st Edition, İstanbul

Contact

Ceyhan Atuf Kansu Caddesi No:122

Balgat/Ankara/TÜRKİYE

**T** +90 312 583 60 00 | [webinfo@iletisim.gov.tr](mailto:webinfo@iletisim.gov.tr) | [www.iletisim.gov.tr](http://www.iletisim.gov.tr)

Print

Prestij Grafik Rek. ve Mat. San. ve Tic. Ltd. Şti.

**T** +90 212 489 40 63, İstanbul

Matbaa Sertifika No: 45590

# CONTENTS

---

## A

- A Pandemic That Respects No Borders: Covid-19 06
- 

## B

- Covid-19 Across The World and In Turkey 80
- 

## C

- Development of Healthcare Services in Turkey: 2002-2020 Period 90
- 

## D

- Fight Against Covid-19 In Turkey:  
Effective Measures and Extensive Support Schemes 104
- 

## E

- Turkey's International Aids and Evacuations 242
- 

## F

- International Comparison of Measures 280
- 

## G

- We Will Succeed Together 324
-



# We Will Succeed Together

## OUR GLOBAL FIGHT AGAINST CORONAVIRUS WILL CONTINUE

As the entire humanity, we are now waging a tough war against an invisible enemy. God willing, with the power of our healthcare infrastructure, we are overcoming a tough period such as the fight against coronavirus by giving an exemplary test. Thanks to the measures we have taken, we are among the countries with the lowest rate of death in the fight against the pandemic. In addition, we have sent medical equipment and supplies to nearly 150 countries around the world regardless of religion, language, race or region. As well as meeting the needs of our own hospitals, we have exported ventilators to many continents from Brazil to Somalia. Along with our means, we also share our country's experience in fighting against the virus with our friends.

We believe that civilization is not a matter of possibility, but of conscience.

The world is moving towards a period where nothing will be the same anymore. This pandemic has reminded us of the fact that our destiny is common. None of us can afford to implement protectionist and unilateral policies. I urge all countries to fairly join the fight against this global health crisis until the entire humanity breathes a sigh of relief.



Recep Tayyip ERDOĞAN  
PRESIDENT OF THE REPUBLIC OF TURKEY





**A PANDEMIC THAT  
RESPECTS NO BORDERS: COVID-19**

# A Pandemic That Respects No Borders: Covid-19

Coronaviridae is defined as a large virus family that can cause diseases in humans or animals. Covid-19, on the other hand, is the name of the contagious diseases caused by the novel coronavirus. The novel coronavirus is a single-chain RNA virus with the positive polarity of the coronavirus family. It has substantial similarities with the SARS-CoV virus that causes the SARS (Severe Acute Respiratory Syndrome) disease.

The novel coronavirus was detected for the first time at a seafood and animal market in Wuhan, China. People infected with the virus mostly showed symptoms such as fever, cough, and respiratory problems. In severe cases, patients might develop pneumonia, severe respiratory distress, renal failure, and eventually they might die. According to findings available, Covid-19 causes more severe problems in older people and people with certain medical conditions such as diabetes, cancer, chronic lung diseases, and cardiovascular diseases.

Covid-19 is contracted to a great extent through saliva particles expelled by coughs and sneezes of infected people. There is currently no confirmed vaccine or treatment for Covid-19.

The virus is predicted to have been transmitted from an animal to a human at a common livestock market in China for the first time. Although the Chinese and the World Health Organization (WHO) officials initially announced there was no human-to-human transmission of the virus, it was not long before it was understood that the virus could spread from human to human.

# Symptoms

SYMPTOMS ANNOUNCED BY THE WORLD HEALTH ORGANIZATION AND OUR  
MINISTRY OF HEALTH CAN BE LISTED AS FOLLOWS:



FEVER



COUGH



SHORTNESS OF BREATH



SORE THROAT



HEADACHE



## False Facts

### FALSE

Covid-19 is a virus produced at a laboratory.

### TRUE

There has been no evidence so far that Covid-19 is a virus produced in a laboratory setting. It came into existence as a consequence of the natural stages of the transformation of microorganisms.

### FALSE

Covid-19 can be transmitted from domestic pets.

### TRUE

Studies have so far shown no case of transmission of Covid-19 from domestic animals to humans.

### FALSE

Each and every Covid-19 case is severe and fatal.

### TRUE

The disease has a mild course of 80%.

### FALSE

Covid-19 is a virus that affects only the elderly population.

### TRUE

Covid-19 can affect all adults. The risk of having a severe course of the disease increases by age.

**FALSE**

A vaccine has been developed for Covid-19, but it has not been introduced to the market yet.

**TRUE**

There is no vaccine available for the treatment of Covid-19.

**FALSE**

Antibiotics are necessary for the treatment of Covid-19.

**TRUE**

Covid-19 is a viral disease and the use of antibiotics does not affect the course of the disease. Antibiotics do not affect viruses.

**FALSE**

Masks, both surgical ones, and normal ones can be reused during the day.

**TRUE**

Surgical masks have a period of use for 3-4 hours and need changing once dampened or stained. Masks lose their quality of protectiveness once washed.

**FALSE**

It is enough to clean the infected surfaces with water and wipe with a wet towel.

**TRUE**

Surfaces should be cleaned with watered/diluted bleach or detergent.

# False Facts

## FALSE

Cleaning the nose and gargling the throat with salted water, or the use of vinegar reduces the infectiousness of the virus.

## TRUE

There is no scientific evidence available on this issue. In fact, salted water, if it has a high concentration of salt, may harm the upper respiratory tract cells.

## FALSE

Hot drinks kill the virus.

## TRUE

Very hot drinks may cause more harm than they provide benefit as they damage 'protective epithelial layer' and 'preventive autoimmune epidemics'.

## FALSE

Eating garlic or onion prevents coronavirus infection.

## TRUE

Garlic and onion are healthy foods that have antimicrobial properties, but there is no scientific evidence that they have a benefit of providing protection against coronavirus.

# Differences Between Diseases

Differences between Covid-19, flu, cold, and allergy

	COLD	ALLERGY	FLU	COVID-19
SEVERE RUNNY NOSE	✓			
SNEEZING	✓	✓		
WHEEZING	✓	✓		
REDNESS IN EYES	✓	✓		
ITCHING	✓	✓		
HEADACHE AND SORE THROAT	✓		✓	
SUDDEN FEVER				✓
DRY COUGH			✓	✓
FATIGUE			✓	✓
SHORTNESS OF BREATH		✓	✓	✓

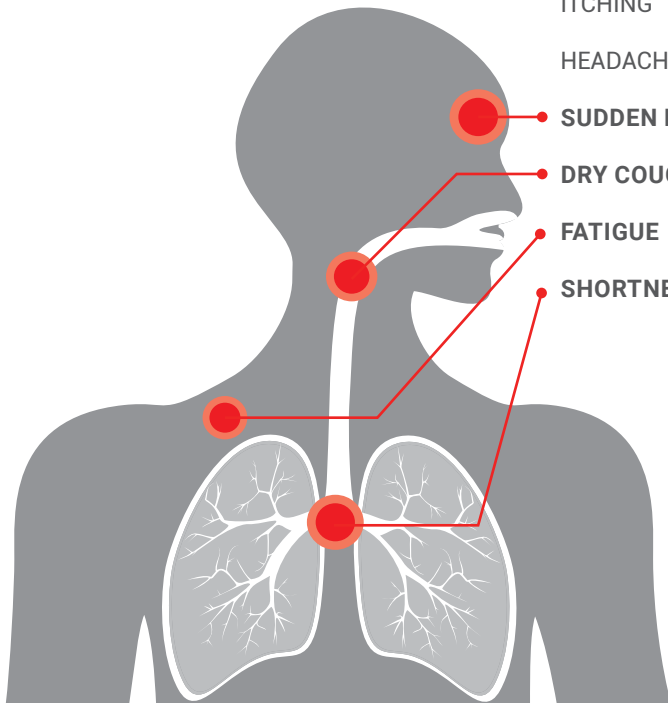

It was announced that the symptoms of flu, common cold, and allergy, typically caused by cold weather, might bear similarities with those of Covid-19, but when accompanied by fever, dry cough, and shortness of breath, a Covid-19 test was necessary.

# Time Line

Some important events throughout the spread of Covid-19 around the world as a global pandemic are listed chronologically as follows:

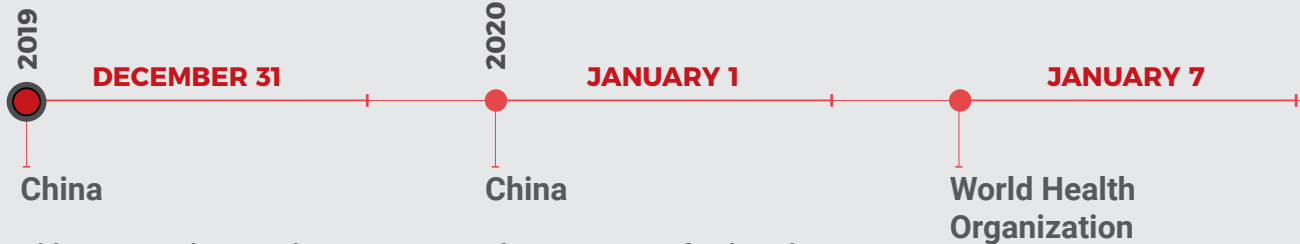

China reported unusual cases of pneumonia to the WHO. The cases emerged in Wuhan, the 11-million population capital of Hubei Province.

The Huanan Seafood Market was closed upon reports of some patients having previously worked there. It was announced that the new virus was not the SARS virus that emerged and killed about 770 people around the world in 2002-2003.

The WHO announced that it was a novel virus of the coronavirus family that caused the disease.



**JANUARY 11****China**

China announced the first death due to the novel coronavirus. It announced that a 61-year-old man who had been to the seafood market for shopping died due to heart failure caused by the virus.

**JANUARY 13****Thailand and Japan**

Thailand and Japan announced one case of coronavirus each. It was announced that both persons had recently been to Wuhan, China.

**Japonya****JANUARY 14****World Health Organization**

The WHO announced that Chinese officials could not find any evidence of human-to-human transmission of the novel coronavirus.



# Time Line

**JANUARY 20**

## World Health Organization

The WHO published the coronavirus report. According to the report, there were a total of 278 confirmed cases infected with coronavirus in China, and 258 of them were in Hubei Province where Wuhan is located.

**The first statement that there was evidence of human-to-human transmission of the virus was published.**

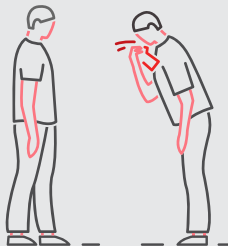

**JANUARY 21-22**

## The USA

It was announced that a person in Washington who had recently returned from Wuhan was infected with the coronavirus.

## China

The number of deaths reached 17 and confirmed cases reached 550 in China on January 22.

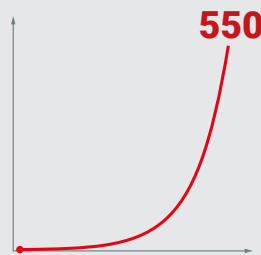

**JANUARY 23**

## China

The news of quarantine from Wuhan clearly showed the high risks of the coronavirus epidemic. Exits from the city were prohibited, and outbound flights and train services were cancelled.

## World Health Organization

The WHO announced that there was no evidence of people infected with the novel coronavirus outside China and that the outbreak did not constitute a “public health emergency of international concern”.

**JANUARY 27****France**

The coronavirus outbreak first reached France among the European countries. The three patients who were placed under quarantine were announced to have been to China.

**JANUARY 30****World Health Organization**

The long-awaited statement from the WHO was received. The Organization declared a global state of emergency. By January 31, India, the Philippines, Russia, Spain, Sweden, and the UK were added to the list of countries having announced confirmed cases.

**FEBRUARY 1****World**

Reports of confirmed cases were announced from Australia, Canada, Germany, Japan, Singapore, the USA, the United Arab Emirates, and Vietnam.

# Time Line

**FEBRUARY 2**

## The Philippines

The first case of death outside China was announced to be in the Philippines.

WHO announced that there was not any known effective treatment against the novel coronavirus.



**FEBRUARY 7**

## China

TA report of death was received that triggered many reactions around the world. Dr. Li Wenliang, who issued the first warning about the coronavirus, was pronounced dead at the hospital where he worked and contracted the virus. In December, the Chinese police had issued him and 7 other doctors a warning notice for sharing information with their friends about the new virus on social media.

**FEBRUARY 10**

## China

The number of deaths reached 908, thus exceeding the total number of deaths during the SARS outbreak in 2002-2003. The number of confirmed cases reached 40,171.



**FEBRUARY 11**

**World Health Organization**

WHO named the novel coronavirus as Covid-19.



**COVID-19**

**FEBRUARY 14**

**Africa**

Covid-19 reached Africa upon Egypt's announcement of the first confirmed case.



**France**

France became the first country in Europe to report a death caused by coronavirus.

**FEBRUARY 19**

**Iran**

Iran announced two confirmed cases of Covid-19 within its borders and both lost their lives.



# Time Line

**FEBRUARY 24**

## Middle East

Kuwait, Bahrain, Iraq, Afghanistan, and Oman announced their first confirmed cases of coronavirus.

## China

The number of deaths reached 2,595 in China where the number of confirmed cases is over 77,200.



**25 ŞUBAT**

## Iran

Deputy Minister of Health of Iran announced testing positive for Covid-19.



**FEBRUARY 26**

## World

The global death toll reached 2,800, and the number of confirmed cases exceeded 80,000. The virus spread to Norway, Romania, Georgia, Pakistan, Macedonia, and Brazil.

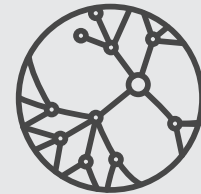

**FEBRUARY 27**

**Europe**

The first cases were confirmed in Estonia, Denmark, Northern Ireland, and the Netherlands.

**MARCH 2**

**Middle East**

The first confirmed cases of coronavirus were announced in Saudi Arabia, Jordan, and Tunisia.

**MARCH 5**

**World**

The pandemic reached 84 countries. The number of confirmed cases exceeded 95,000 across the world while the number of deaths exceeded 3,300.

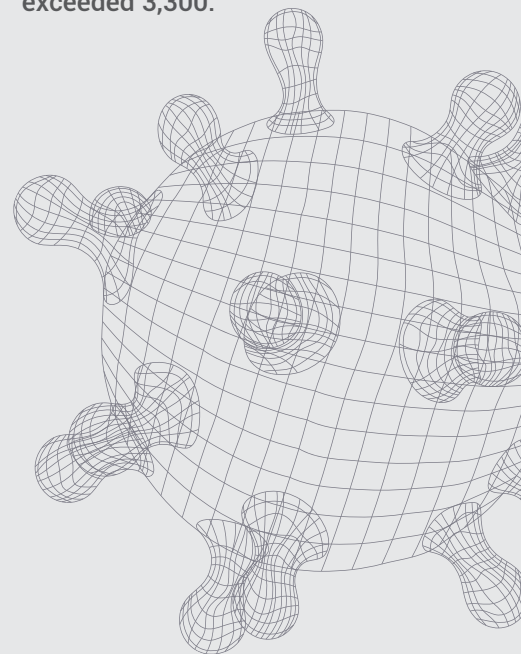

# Time Line

**MARCH 6**

## World

The number of people infected with the pandemic disease exceeded 100,000. For the first time in Europe, one of the people who lost their lives was a Turkish national.

**MARCH 7**

## World

In the pandemic that reached 90 countries, the number of confirmed cases exceeded 102,000 while the death toll exceeded 3,500.

**MARCH 9**

## World

The number of deaths around the world exceeded 110,000. The stock markets around the world went through a 'Black Monday'.



## Global Economy

The indexes at the Wall Street stock exchanges started Monday with a 7% fall and the trading halted for 15 minutes. London Stock Exchange and Frankfurt Stock Exchange lost value over 7%. The 20% fall in the US crude oil prices was the biggest daily drop since the Gulf War in 1991.

MARCH 11

**Europe**

The WHO characterized Covid-19 as a pandemic.

**Turkey**

The first case was confirmed in Turkey on the same day.



MARCH 12

**World**

The number of deaths in the world exceeded 4,600 while the number of confirmed cases exceeded 126,000.

**China**

China announced the lowest daily rise in the number of cases with 15 new cases for the first time in seven weeks during the outbreak.

**The USA**

President Trump declared a national state of emergency.

MARCH 17

**Turkey**

Minister of Health Fahrettin Koca announced the first death caused by Covid-19.

**Italy**

In Italy, where the pandemic is most severe, a total of 345 people lost their lives in 24 hours and the number of deaths reached 2,503. The total number of confirmed cases rose from 27,980 to 31,506.

**European Union**

The European Union closed its border gates with no non-EU countries.

# Time Line

**MARCH 18**

## World

The number of confirmed cases around the world reached 200,000. The number of deaths exceeded 8,000.

## Europe

Europe, with the number of deaths at 3,421 currently, surpassed Asia, the centre of the pandemic. President of the European Commission Ursula von der Leyen **confessed that the EU was very late to take action in the fight against the pandemic.**

**MARCH 19**

## China

Hubei Province and Wuhan, where the pandemic broke out, recorded no new confirmed cases for the first time.

**MARCH 23**

## World

The number of deaths in the world exceeded 15,400.

## World Health Organization

The WHO issued a warning that the pandemic had gained momentum.

## Global Economy

The International Monetary Fund announced its prediction that in 2020 the world might go through a worse recession than the one that was caused by the 2008-2009 financial crisis due to the Covid-19 pandemic.

**MARCH 24****Tokyo 2020 Olympic Games**

Tokyo 2020 Olympic Games were postponed for one year.

**MARCH 25****China**

The months-long curfew in Hubei Province, China, where the Covid-19 broke out, was ended.

**MARCH 26****G-20 Summit**

G-20 The Summit was held via video-conference.

**The USA**

The number of people who applied for relief because of losing their jobs exceeded three million in a week. The FED Chairman Jerome Powell stated that the US economy may already be in recession.

# Time Line

**MARCH 27**

## **China**

China, where the Covid-19 pandemic first broke out, imposed a temporary entry ban for foreigners into the country.

## **The USA**

US President Donald Trump signed the largest economic stimulus package in the history of his country.

President Donald Trump signed an executive order to direct General Motors to manufacture ventilators in the fight against Covid-19, pursuant to Defence Production Act.

**MARCH 28**

## **World**

The number of deaths caused by the coronavirus pandemic that affects the whole world reached 31,700 while the number of people infected with the virus reached 678,000, and the number of recovered patients reached 145,600.

## **Russia**

The Federal Medical-Biological Agency (FMBA) of Russia announced to have developed the medication to treat the novel coronavirus.

## **China**

China issued a warning about the second wave of the disease upon the increasing number of patients infected with Covid-19 coming from abroad.

## **The USA**

An infant younger than twelve months died of Covid-19 in the USA.

## **France**

It was found out that a religious gathering that took place at a church in Mulhouse, France, in February caused thousands of new cases of Covid-19.

## MARCH 31

## World

The UN Secretary-General Antonio Guterres said, "Covid-19 is the greatest test that we have faced together since World War II."

The number of deaths caused by Covid-19 in the world reached 40,639 while the number of confirmed cases reached 823,284.

President of the Republic of Turkey held a telephone conversation with US President Donald Trump. The two leaders agreed that the fight against the pandemic would be successful if global solidarity and cooperation were to be ensured, and agreed to take necessary steps to share best practices, data, and experience to take the various effects of the pandemic under control.

A newborn baby was diagnosed with coronavirus in Mashhad, Iran.

A 12-year old girl lost her life due to coronavirus in Belgium.

The European Organization for the Safety of Air Navigation announced that the air traffic within the European network decreased by 88% due to the Covid-19 pandemic.

The Palestine-Turkey Friendship Hospital established by Turkey in Gaza began operating as part of the efforts in the fight against the coronavirus pandemic amid Israeli blockade.

The first case of coronavirus among the refugees placed at camps in Greece was confirmed.

## APRIL 1

## World

The total number of confirmed cases around the world reached 903,819.

Over the last 24 hours, the number of people who lost their lives due to the coronavirus pandemic in the USA increased by 920 and reached 4,090. The number of confirmed cases in the country increased by 25,023 and reached 189,633 over the last 24 hours.

The planes of the Turkish Armed Forces carrying medical supplies within the framework of the fight against Covid-19 arrived in Madrid, Spain, and Rome, Italy. NATO Secretary-General Jens Stoltenberg extended his gratitude to Turkey for its aids.

# Time Line

**APRIL 2**

## World

Across the world, the total number of confirmed cases exceeded 910,000, the death toll reached 46,000, and the total number of recoveries reached 193,000 as of April 2, 2020, 00:00.

The Parliamentary Speaker of the Grand National Assembly of Turkey (GNAT) sent a letter to the parliamentary speakers of 44 countries and encouraged acting as one in the fight against coronavirus.

The AN-124 military cargo plane carrying medical supplies from Russia to the USA within the framework of the fight against Covid-19 landed at JFK International Airport, New York.

The Meeting of NATO Foreign Ministers was held via video-conference for the first time in NATO's 70-year history.

**APRIL 3**

## World

Across the world, the number of people infected with coronavirus exceeded 1,000,000, the number of deaths exceeded 54,000, and the number of recoveries exceeded 220,000.

Mölnlycke, a Sweden based medical products and solutions company, announced that France seized millions of face masks and gloves that the company imported from China for Italy and Spain.

UN General Assembly adopted by consensus the first resolution calling for increased global solidarity and international cooperation against the Covid-19 pandemic.

It was announced that German Chancellor Angela Merkel ended her self-quarantine, which she imposed as a preventive measure against the Covid-19 pandemic.

**APRIL 4**

## World

The number of confirmed cases around the world reached 1,118,244. 59,220 people lost their lives while the number of recoveries reached 229,157.

## The USA

Five infants were diagnosed with Covid-19 in Maryland, the USA.

APRIL 5

**World**

Across the world, the total number of confirmed cases exceeded 1,200,000. The death toll reached 64,747. The total number of recoveries exceeded 250,000.

Turkic Council Secretary General Baghdad Amreyev stated that the member states displayed great cooperation against Covid-19 and the Turkic world would also continue to cooperate with the rest of the international community in the fight against the pandemic.

APRIL 6

**The United Kingdom**

Prime Minister Boris Johnson who was undergoing treatment for the novel coronavirus was moved to intensive care.

**World Health Organization**

WHO Director-General Tedros Adhanom Ghebreyesus stated that the two French doctors' proposal to test Covid-19 vaccines and medications in Africa was racist, embarrassing, appalling, and a hangover from a colonial mentality, and said, "Africa cannot and will not be a testing ground for any vaccine."

**France**

French Minister of Finance Bruno Le Maire stated that France might likely experience the greatest economic contraction since World War II.

**Singapore**

Approximately 20 thousand foreign workers were placed in quarantine in Singapore.

APRIL 7

**World**

Across the world, the number of recoveries exceeded 285,000. The number of deaths reached 75,299, and the number of confirmed cases reached 1,352,287.

**China**

China did not report any case of death due to Covid-19 for the first time.

**Norway**

Norwegian Minister of Health Bent Høie reported that they took Covid-19 under control in their country.

# Time Line

**APRIL 7**

## **Saudi Arabia**

Curfews were declared for four provinces and five metropolitan cities in Saudi Arabia within the framework of the fight against coronavirus.

## **TRNC**

The third case of death was recorded in the TRNC, as well as the first death case of a TRNC national due to Covid-19.

## **Japan**

A state of emergency was declared against the Covid-19 pandemic in seven states in Japan, including Tokyo and Osaka.

## **Malaysia**

Malaysia's administrative capital Putrajaya was included in the cities declared a red zone due to Covid-19.

## **USA**

US President Trump accused the WHO of being too China-centric in its handling of the Covid-19 pandemic.

**APRIL 8**

## **World**

The total number of deaths reached 84,792, the total number of confirmed cases reached 1,462,698, and the total number of recoveries reached 313,019.

## **Turkey**

President Erdoğan held a phone conversation with President Xi Jinping of China and discussed ways of cooperation in the battle against Covid-19, as well as bilateral relations.

APRIL 9

**World**

Across the world, the total number of confirmed cases exceeded 1,513,358. The total number of recoveries exceeded 340,000.

**The Balkans**

The medical supplies Turkey sent as part of the fight against coronavirus arrived in Serbia, Bosnia and Herzegovina, Montenegro, and Kosovo.

APRIL 10

**World**

Across the world, the total number of confirmed cases exceeded 1,650,000, the total number of deaths exceeded 100,000, and the total number of recovered patients exceeded 365,000.

**World Health Organization**

WHO Representative and Head of Country Office in Turkey Pavel Ursu stated that Turkey was an exemplary country thanks to its diagnostic capacity and tremendous efforts in treatment in its fight against Covid-19, and was running the process transparently.

**Turkey**

A TAF plane en route to the UK with medical supplies prepared by the Ministry of Health upon President Recep Tayyip Erdoğan's instruction took off from Etimesgut, Ankara.

**Turkey**

Medical supplies were dispatched to the people of Libya and cooperation-consultancy teams on education operating in the region upon the instruction of the President of the Republic of Turkey Recep Tayyip Erdoğan.

**Turkey**

Turkey sent food aid to Lebanon as part of the fight against Covid-19.

**European Union**

EU countries agreed on an economic package of approximately EUR 540 billion to mitigate the effects of Covid-19.

**Sweden**

In Södertälje, Sweden, 81-year old Hanna Altınsu infected with Covid-19 lost her life because she was not admitted to intensive care despite vacant beds.

# Time Line

**APRIL 11**

## **World**

The total number of confirmed cases reached 1,715,143, the death toll reached 104,800, and the total number of recoveries reached 389,374.

## **UEFA Champions League**

UEFA Champions League 2020 Final was cancelled due to the Covid-19 pandemic.

**APRIL 12**

## **World**

It was announced that air pollution decreased by 30% in metropolitan cities upon the majority of people heeding the "Stay at Home!" call.

## **The United Kingdom**

UK Prime Minister Boris Johnson, who was receiving Covid-19 treatment, was discharged from St. Thomas Hospital.

**APRIL 13**

## **World**

The total number of deaths is 115, 286. The total number of confirmed cases is over 1,864,000.

## **Russia**

Russian President Vladimir Putin announced in his statement on the coronavirus pandemic that the situation was deteriorating in his country. A digital permit system was introduced in Moscow to replace the previously imposed lockdown.

## **Pakistan**

Prime Minister Imran Khan of Pakistan stated that they entered into a new challenging period due to the practices such as the "suspension of business" adopted in the battle against coronavirus in developing countries that are under heavy debt load.

**APRIL 14****World**

Across the world, the total number of confirmed cases reached 1,975,584, the total number of deaths reached 124,556, and the number of recoveries reached 465,556.

**UNICEF**

UNICEF issued a warning that the suspension of the delivery of measles vaccines in 24 countries due to the Covid-19 pandemic might affect 117 million children.

**China**

The Chinese State Council reported the approval of the start of clinical trials of the 2 more new vaccines developed against coronavirus.

**Brazil**

Brazil announced the death of two persons due to the side effects of chloroquine diphosphate at the clinical trials to find out its effects on the coronavirus treatment.

**European Union**

EU increased its annual budget by EUR 3.5 billion for the fight against coronavirus.

**Uganda**

A popular musician and MP Bobi Wine of Uganda launched a campaign to save Africans and Afro-Americans from the country as they were accused of xenophobia and faced maltreatment upon claims that they caused the spread of coronavirus again in China.

**Indonesia**

President of Indonesia Joko Widodo declared Covid-19 pandemic a national disaster as part of the fight against the novel coronavirus spreading in the country.

**APRIL 15**

## World

Across the world, the total number of deaths due to Covid-19 reached 130,802, the total number of confirmed cases reached 2,035,737, and the total number of recoveries reached 503,386.

## Turkey

Turkish Cooperation and Coordination Agency (TİKA) sent over 63 thousand masks, protective equipment, and sanitation equipment supplies to Pakistan for use in the fight against the Covid-19 pandemic.

## Gaza

TİKA delivered health packages and disinfectants to 2 thousand families in the Gaza Strip within the scope of the fight against Covid-19.

## NATO

NATO Secretary-General Jens Stoltenberg stated that Turkey was one of the countries to offer the most help to the allies, and the Turkish military aircraft carrying medical supplies and personal protective equipment to the UK used the unique NATO call sign for the first time.

## The USA

US President Trump accused the WHO of playing an important role in the spread of the pandemic around the world and claimed that the organization misled the world. He instructed his administration to halt funding to the WHO.

**APRIL 16****World**

TİKA delivered food aid packages to 600 households in need of support in Kosovo as part of the fight against coronavirus.

**World Health Organization**

WHO Regional Director for Europe Hans Kluge, on behalf of the WHO, expressed his gratitude to Turkey for its cooperation and medical aid to particularly the UK, Italy, Spain, and the Balkan countries.

**World**

Nigerian security forces killed 18 civilians who defied the curfew imposed due to the Covid-19 pandemic.

**World**

The Libyan Government of National Accord announced the imposition of a 10-day curfew effective as of Friday in the fight against Covid-19.

**Ecuador**

A total of 1424 corpses dumped by the deceased people's families and relatives were collected from homes and hospitals in Guayaquil, which is considered the epicentre of Covid-19 in Ecuador.

APRIL 17

## World

The total number of confirmed cases is over 2,200,000, the total number of deaths is over 145,000, and the total number of recovered patients is over 560,000.

## Turkey

President Recep Tayyip Erdoğan held a phone conversation with Japanese Prime Minister Shinzo Abe and discussed ways of cooperation in the battle against coronavirus, as well as bilateral relations.

## Romania

TİKA delivered 1500 food and sanitary supply packages to families over 65 years of age and in need.

## The USA

US President Trump announced that the measures against Covid-19 in the country would be relaxed in three phases, with the decision to do so vested in state governors.

## UNECA

United Nations Economic Commission for Africa (UNECA) announced that 300,000 to 3.3 million people might lose their lives due to Covid-19 unless sufficient measures were taken in Africa.

## Germany

German Minister of Health Jens Spahn stated that the Covid-19 pandemic in Germany became controllable again.

## France

French Minister of the Armed Forces Florence Parly announced in her statement to the parliament that almost half of the 2,300 crew at the Charles de Gaulle aircraft carrier tested positive for Covid-19.

## United Nations

United Nations Food and Agriculture Organization (FAO): "As the virus spreads and cases mount, and block downs increase there are seemingly countless ways the food system will be tested and strained in the coming weeks and months."

## World Health Organization

WHO Regional Director for Africa Dr. Matshidiso Moeti stated that US halt of funding support for the WHO would undermine the efforts in the fight against diseases such as poliomyelitis, malaria, and AIDS in Africa.

**APRIL 18****World**

Across the world, the total number of confirmed cases reached 1,715,143, the death toll reached 104,800, and the number of recoveries reached 389,374.

**The USA**

US President Donald Trump stated that they saved millions of lives thanks to the measures they took, and although they had projected a total number of deaths between 100,000 and 240,000 until recently, they now expected the actual number to be less than 100,000.

**APRIL 19****World**

Across the world, the total number of confirmed cases rose to 2,367,689, the total death toll to 162,958, and the total number of recoveries to 610,080.

**APRIL 20****World**

Across the world, the total number of confirmed cases reached 2,443,211, the total number of deaths reached 167,953, and the number of recoveries reached 640,252.

# Time Line

**APRIL 21**

## World

Across the world, the number of confirmed cases reached 2,529,094, the death toll reached 174,573, and the number of recoveries reached 667,609.

## Australia

Australia's second-largest airline company Virgin Australia entered voluntary administration due to its flights reaching a stalemate caused by travel bans against the spread of Covid-19.

## Turkey

President of the Republic of Turkey Recep Tayyip Erdoğan held a phone conversation with Russian President Putin and discussed ways of cooperation in the fight against Covid-19, as well as bilateral relations, and regional developments.

## Pakistan

Federal Minister for Information and Broadcasting Firdous Ashiq Awan announced that it would send 9 million chloroquine tablets to the USA, Turkey, Saudi Arabia, the UK, Italy, Kazakhstan, and Qatar.

## Saudi Arabia

It was announced that tarawih prayers would be performed without congregation at Haram al-Sharif in Mecca and Masjid al-Nabawi in Medina during the month of Ramadan.

**APRIL 22**

## World

Across the world, the death toll from Covid-19 reached 181,170, the total number of confirmed cases reached 2,594,835, and the total number of recoveries reached 719,695.

## The UK

A Royal Air Force cargo plane loaded with medical supplies from Turkey arrived in the UK..

APRIL 23

## Leaders

President of the Republic of Turkey Recep Tayyip Erdoğan held telephone conversations, discussing cooperation in the fight against Covid-19 and bilateral relations, with President of France Emmanuel Macron, President of Uzbekistan Shavkat Mirziyoyev, President of Iran Rouhani, Prime Minister of Italy Giuseppe Conte, President of Equatorial Guinea Teodoro Obiang Nguema Mbasogo, and President of Somalia Muhammad Abdullah Farmajo.

## Serbia

TİKA (Turkish Cooperation and Coordination Agency), provided food and sanitation supplies to 250 households in need of aid in Serbia as part of the fight against Covid-19.

## World

The number of people who lost their lives due to Covid-19 reached 187,923, the total number of confirmed cases reached 2,682,745, and the total number of recoveries reached 736,405.

## World Health Organization

The WHO issued a warning against the yellow fever outbreak for Ethiopia, following South Sudan. The number of cases was reported to go up from 3, at the beginning of March, to 85 in Gura.

## United Nations

United Nations Economic and Social Commission for West Asia (ESCWA) stated that Covid-19 would affect the Arab region the most.

APRIL 24

## World

Across the world, the number of confirmed cases exceeded 2,750,000, the death toll exceeded 190,000, and the number of recoveries exceeded 760,000..

## Turkey

President of the Republic of Turkey Recep Tayyip Erdoğan talked with German Chancellor Angela Merkel over the phone and discussed the ways of cooperation on prospective steps in the fight against Covid-19 and the post-pandemic period.

## United Nations

Due to the corona pandemic, UN Secretary-General Antonio Guterres called for a global ceasefire so that a battle could be waged against the pandemic.

**APRIL 24**

## **USA**

The US House of Representatives approved a 484-billion-Dollar coronavirus relief bill funding small businesses and health institutions and more coronavirus testing.

## **United Kingdom**

In the United Kingdom, the University of Oxford began the first human trials of a potential Covid-19 vaccine.

## **Albania**

TIKA delivered 3 thousand 500 aid packages to the needy families in Albania due to the Covid-19 pandemic and the beginning of the month of Ramadan.

## **Afghanistan**

TIKA Mazar-i Sharif Office donated 101 thousand masks to Afghanistan as part of the fight against the Covid-19 pandemic.

## **France**

President of France Emmanuel Macron stated that Europe had no future if it failed to find a joint solution to the economic crisis caused by Covid-19.

## **World Health Organization**

During a press conference, WHO Regional Director for Africa, Dr. Matshidiso Moeti urged all countries to maintain malaria prevention efforts. WHO warned that due to the damage incurred by Covid-19 to the supply chain, malaria deaths could reach the highest level seen since 2000.

**APRIL 25****World**

Across the world, the number of people infected with Covid-19 reached 2 million 871 thousand 247, the death toll rose to 200 thousand 569 while the number of recoveries reached 823 thousand 306.

**USA**

Three states in the USA eased some of the restrictions under the scope of the fight against the Covid-19 pandemic. While Georgia and Oklahoma allowed shops including bowling alleys, hair styling saloons and spas to reopen, Alaska lifted the restrictions on restaurants and retail stores.

**Iran**

Iran reopened parks and gardens that were closed as part of measures, after almost a month.

**China**

China rejected calls for an investigation into the origin of the Covid-19 pandemic.

**Kosovo**

The second batch of medical aid sent by Turkey to Kosovo as part of the fight against Covid-19 arrived in capital Pristine.

**World Health Organization**

WHO stated that there was no evidence that people who recovered from Covid-19 and had antibodies were protected from a second infection. WHO warned against the decision of some countries to give an “immunity passport” or “risk-free certificate” to individuals who recovered from Covid-19. WHO pointed out that the use of such certificates might increase the risks of continued transmission.

**UNICEF**

UNICEF stated that the Covid-19 pandemic disrupted global immunization services and that this situation could create pathways to disastrous outbreaks this year and well beyond.

# Time Line

**APRIL 26**

## World

Across the world, the number of people infected with Covid-19 reached 2 million 957 thousand 829, the death toll rose to 205 thousand 395 while the number of recoveries reached 867 thousand 546.

## Bulgaria

President of the Republic of Turkey Recep Tayyip Erdoğan talked with Prime Minister of Bulgaria Boyko Borisov over the phone. During the conversation, they discussed the issues of support and cooperation in the fight against Covid-19.

## Sweden

Emrullah Gulusken, 47, who was not treated and sent home in the Swedish city of Malmo although he tested positive for Covid-19, was flown to Turkey along with his children Esmâ, Samira, and Mahmut by an air ambulance of the Turkish Ministry of Health.

## Syria

Turkish Red Crescent started distributing food parcels for Ramadan in Syria's Ras al-Ayn and Tal Abyad districts cleared from terrorism with the Operation Peace Spring.

## Italy

Prime Minister of Italy Giuseppe Conte stated that starting on May 4, they would ease the strict containment measures in place due to the Covid-19 pandemic initially for sectors like construction and manufacturing, and many firms. Prime Minister Conte said they were thinking of reopening schools in September.

APRIL 27

## World

Across the world, the number of people infected with Covid-19 reached 3 million 23 thousand 205. 208 thousand 883 people lost their lives due to Covid-19. The number of recoveries across the world reached 893 thousand 120.

## United Kingdom

British Prime Minister Boris Johnson announced that the UK came to the end of the first phase of the fight against Covid-19, and following the successful completion of the first phase, the second phase, in which the disease would be contained, infection rate would fall and economic and social restrictions would be gradually refined, would begin.

## New Zealand

Prime Minister of New Zealand Jacinda Ardern stated that the country "won" the fight against Covid-19. Deciding that the disease spread was taken under control, the government announced that, as of April 27, it would lift the state of emergency and lockdown except for essential errands imposed since March 25.

## China

It was announced that clinical studies started on the third vaccine candidate in China where Covid-19 broke out.

APRIL 28

## World

The number of people infected with Covid-19 across the world reached 3 million 96 thousand 708, the total death toll reached 213 thousand 541, the number of recoveries reached 938 thousand 610.

## Turkey

A military cargo plane carrying Turkey's medical aid to the US for the fight against Covid-19 departed from Ankara.

## China

Chinese National Health Commission stated that the last 12 patients under treatment in the Hubei province of China, where Covid-19 originated, were discharged on Sunday. It was noted that 582 asymptomatic cases that were positive for Covid-19 were held under medical observation in the province.

## Turkey

Turkic Council Health Ministers agreed to bolster cooperation in the fight against Covid-19.

## Pakistan

The second batch of protective medical equipment that Turkey agreed to send to Pakistan as part of the fight against Covid-19 arrived in the country.

## Turkey

In Turkey, the first Covid-19 patient who received plasma therapy recovered.

# Time Line

**APRIL 29**

○ US Secretary of State Pompeo expressed his gratitude for the medical aid Turkey sent to the United States. In a post he shared on his Twitter account, Pompeo stated the following: "During times of crisis, NATO allies must stand together. We thank Turkey for their generous donation of medical supplies and protective equipment to help us fight COVID-19 in our hardest-hit areas. Americans are grateful for your friendship, partnership, and support."

○ Turkish Cooperation and Coordination Agency (TIKA) sent food aid packages to 700 families in the economically fragile Gafsa and Kassarın provinces in Tunisia.

○ The Ministry of Hajj and Umrah of Saudi Arabia announced that Masjid Al-Haram and Masjid Al-Nabawi would open their doors soon provided that Muslim believers abode by the relevant procedures.

**APRIL 30**

○ Within the scope of the fight against the novel coronavirus, TIKA distributed 5,000 aid packages consisting of hygiene materials to the Rohingya Muslims in the Cox's Bazar region of Bangladesh.

○ As part of the second round of medical aid to the USA, one of the countries most affected by the COVID-19 pandemic, the military cargo aircraft carrying aid departed from the Etimesgut Military Airport to the USA.

**MAY 1**

○ President of the Republic of Turkey Recep Tayyip Erdoğan and President of the European Commission Ursula von der Leyen talked over the phone. During the conversation, opportunities for cooperation in the fight against COVID-19, mutual steps to be taken in the post-epidemic period and regional issues were discussed.

○ Turkish Airlines cargo aircraft carrying medical supplies sent to Palestine by Turkey as part of the fight against COVID-19 arrived at Ben Gurion Airport in Tel Aviv. Among the 15 tons of materials were 40 thousand diagnostic kits, 100 thousand N95 masks, 40 thousand overalls, 100 thousand gloves, 20 thousand protective goggles, two thousand litres of disinfectant, 20 thousand nasal cannulae, two thousand oxygen masks, and four PCR machines.

## MAY 2

- The quarantine regime implemented in Azerbaijan as part of the fight against COVID-19 until May 4 was extended to May 31 while some restrictions were lifted.
- In the USA, whose economy was negatively affected by the COVID-19 pandemic, the normalization process began gradually in 11 states, including Alabama, Arizona, Iowa, Ohio, and Texas.
- Russian Prime Minister Mikhail Mishustin announced that he tested positive for COVID-19.
- US President Donald Trump has announced that he has seen evidence of the novel coronavirus originating from a laboratory in Wuhan, China, but is unable to disclose information at this point.
- Across the world, the number of people infected with COVID-19 reached 3 million 446 thousand 562, the death toll reached 242 thousand 675 while the number of recoveries reached 1 million 102 thousand 408.
- Turkish Armed Forces C-130 military cargo aircraft carrying medical supplies sent to the USA arrived at Andrews Air Base near the capital Washington. Thus, the second aid package of Turkey was delivered to the United States, after the first one.
- Turkey sent medical supplies including domestic ventilators for intensive care to Somalia as part of the fight against the COVID-19 pandemic. Somalia was the first foreign country to which the domestic ventilators for intensive care were sent.

## MAY 3

- Across the world, the number of people infected with COVID-19 reached 3 million 523 thousand 355, the death toll reached 246 thousand 394 while the number of recoveries reached 1 million 141 thousand 898.
- US Secretary of State Mike Pompeo said, "We are grateful for our NATO ally Turkey. Their support is helping U.S companies who are doing good work to help fight COVID-19 around the world. We will get through this together, and come out stronger than before".
- Bulgarian Prime Minister Boyko Borisov announced that they began to ease the coronavirus measures in the country.

# Time Line

## MAY 4

- The second batch of medical supplies Turkey sent as part of the fight against novel coronavirus reached Somalia.
- A commitment of 7.4 billion Euros was made for diagnosis, treatment, and vaccine development at the Coronavirus Global Response International Pledging Event.
- In Italy, strict measures against the pandemic began to be eased gradually. More than 4 million employees in the country returned to work.
- The partial lockdown implemented since March 23, as part of the coronavirus measures in the TRNC ended.
- In Kazakhstan, the measures against coronavirus began to be eased.
- US President Donald Trump indicated that life could gradually return to normal in some states in the USA.

## MAY 5

- Medical supplies sent by Turkey to Palestine as part of the fight against coronavirus were received with a ceremony.
- US President Donald Trump, who blames China for the virus becoming a global epidemic, stated the following: "From the intelligence reports, we understand that bad things have happened in China. Let's face it. China did not deliberately reveal this (virus), but the virus somehow came out of it (Wuhan)."
- New Zealand Prime Minister Jacinda Ardern stated that the borders of her country, which has won the fight against the novel coronavirus (COVID-19), would be closed to countries other than Australia "for a long time".
- In Spain, the measures against coronavirus began to be eased gradually.
- Businesses in Ontario, Quebec, Alberta, Manitoba, and Saskatchewan provinces in Canada were allowed to reopen.
- Schools, which have been closed for 3 months to prevent the spread of COVID-19 in Vietnam, have begun to reopen.
- In Malaysia, businesses affiliated with the economic sector, whose activities have been discontinued for some time, have resumed operations.

## MAY 6

- Turkish Airlines (THY), which suspended domestic and international flights due to the novel coronavirus, prepared a draft flight schedule for June, July, and August.
- TIKA announced that it established a mask manufacturing workshop to support the fight against coronavirus in Mongolia.
- BioNTech, a Biotechnology company in Germany whose co-founder is a Turkish Scientist Professor Uğur Şahin, started testing the potential COVID-19 vaccine, developed with the American Pfizer pharmaceutical company, on people in the USA.

## MAY 7

- Turkey brought back 9 Ukrainian citizens, whose request to repatriate was rejected by 6 countries, to their country from Argentina.
- Turkish Red Crescent donated food aid to families in need in Indonesia.
- As part of the fight against coronavirus, TIKA provided 30 thousand surgical masks to healthcare workers in the provinces of Algeria and Oran.
- TIKA announced that, due to the month of Ramadan and novel coronavirus, it would distribute 3,500 aid packages in North Macedonia.
- The United Nations World Tourism Organization (UNWTO) reported that the number of international tourists may decrease by 58 to 78 percent this year due to the novel coronavirus.

## MAY 8

- Across the world, the number of people infected with COVID-19 exceeded 3 million 980 thousand, the death toll exceeded 274 thousand while the number of recoveries exceeded 1 million 372 thousand.
- The Republic of Turkey sent medical supplies to be used in the fight against the COVID-19 to Ukraine.
- The Republic of Turkey sent medical supplies to be used in the fight against the COVID-19 to Tunisia.
- It was announced that the ventilators sent from Turkey, as part of the fight against COVID-19, reached Lithuania.
- In his video message, United Nations Secretary-General Antonio Guterres stated, "COVID-19 does not care who we are, where we live or what we believe. Yet the pandemic continues to unleash a tsunami of hate and xenophobia, scapegoating, and scare-mongering."
- WHO reported that COVID-19 was bat-borne and the seafood market in Wuhan the Hubei province in China played a role in the outbreak of the pandemic.

# Time Line

## MAY 9

- Across the world, the number of people infected with COVID-19 reached 4 million 57 thousand 781, the death toll reached 277 thousand 944 while the number of recoveries reached 1 million 414 thousand 721.
- TIKA started distributing food packages and hygiene kits to 1500 families in Kenya due to the month of Ramadan and the novel coronavirus pandemic.
- As part of the fight against COVID-19, Turkey sent medical supplies to Kazakhstan.
- The U.S. Food and Drug Administration (FDA) approved a test applicable at home for novel coronavirus diagnosis. In a written statement from the FDA, it was announced that it granted "emergency approval" to the test which was developed by Rutgers University and which could be conducted with a saliva sample at home.
- In France, the government decided to take the first step towards gradually easing the measures taken against the COVID-19 pandemic as of May 11.

## MAY 10

- Across the world, the number of people infected with COVID-19 reached 4 million 146 thousand 48, the death toll reached 281 thousand 957 while the number of recoveries reached 1 million 463 thousand 3.
- In Germany, the process to ease coronavirus measures has started to progress.
- It was claimed that China forced WHO to state that "it could not be transmitted from person to person" when the novel coronavirus first appeared.

## MAY 11

- President of the Republic of Turkey Recep Tayyip Erdoğan and German Chancellor Angela Merkel talked over the phone. During the conversation, two leaders discussed the coronavirus pandemic affecting the whole world and the cooperation regarding the steps to be taken in the post-pandemic period.
- Turkey announced that it would donate medical supplies including 40 thousand COVID-19 PCR tests, 4 PCR machines, 100 thousand N95-type masks 2 tons of hand disinfectants to Palestine, in the period of fighting against novel coronavirus pandemic.
- TIKA provided food and hygiene supplies to families in need who were affected by the coronavirus pandemic in Guinea and Afghanistan.

## MAY 12

○ Since the number of COVID-19 cases reached 221 thousand 344, Russia ranked third in the world, leaving behind Italy and the UK.

○ In France, the measures taken against the coronavirus pandemic began to be eased gradually.

○ The estimated date to resume the Spanish football league La Liga has been announced as June 12.

○ Turkey sent 75 thousand medical masks, 10 thousand nitrile gloves, 10 thousand protective overalls, two thousand protective goggles, two thousand N149 masks to North Macedonia, and 75 thousand medical masks, four thousand nitrile gloves, two thousand protective overalls, two thousand protective goggles to Albania, as part of the fight against COVID-19.

○ Minister of Foreign Affairs of Kyrgyzstan Chingiz Aidarbekov, thanked Turkey for its support in bringing back the Kyrgyz citizens to the country.

○ The military cargo aircraft carrying medical supplies to North Macedonia, sent by the Turkish Red Crescent, to support the fight against the novel coronavirus, arrived at the capital Skopje.

○ As part of the fight against the novel coronavirus pandemic and Ramadan activities, TIKA provided 1000 families in need in Bosnia Herzegovina with food and hygiene supplies.

○ The death toll in the USA, turning into the epicentre of the pandemic, increased to 81 thousand 157, while the number of cases exceeded 1 million 370 thousand. The number of recoveries in the country exceeded 255 thousand.

○ With the number of confirmed COVID-19 cases reaching 232 thousand 243, Russia became the second country where the pandemic spread the most.

○ Kremlin Spokesperson Peskov stated that he tested positive for COVID-19 and was receiving treatment in the hospital.

# Time Line

**MAY 13**

- Across the world, the death toll caused by COVID-19 reached 294,784, the total number of cases reached 4,384,627 and the number of recoveries reached 1,626,315.
- Indian pharmaceutical company Glenmark has received approval to use Favipiravir -influenza drug- in the clinical trials for use in the treatment of novel coronavirus.
- US President Donald Trump said in his Twitter post, "As I have said for a long time, dealing with China is a very expensive thing to do." Expressing that, shortly after signing a trade agreement with China, the whole world was hit by the COVID-19 pandemic from China, Trump stated that "100 Trade Deals wouldn't make up the difference - and all those innocent lives lost."

**MAY 14**

- As part of the fight against the novel coronavirus, TIKA provided food aid to families in need in Johannesburg, South African Republic.
- TIKA Kabul Office provided medical supplies and equipment to the Ministry of Health of Afghanistan to support Afghanistan in the fight against the novel coronavirus.
- The second batch of the medical supplies sent to Libya by Turkey to support the fight against the novel coronavirus was received by the Ministry of Health's Emergency Management Department.
- TIKA provided food, cleaning, and hygiene products to those who are affected by the virus in the capital of Bogota and Cundinamarca, the epicentre of the COVID-19 pandemic in Colombia.
- Turkish Red Crescent distributed 3,500 food packages to the needy and displaced families in three cities of Yemen.
- The medical supplies sent by Turkey as part of the fight against COVID-19 arrived in Gaza.
- The Turkish American National Steering Committee helped by sending equipment for healthcare professionals in New York and New Jersey, fighting against the novel coronavirus pandemic.
- Underlining that the COVID-19 measures would not be lifted rapidly, Ursula von der Leyen, President of the EU Commission said, "Our economies and societies will open slowly, cautiously and gradually."

## MAY 15

○ President of the Republic of Turkey Recep Tayyip Erdoğan talked to Jens Stoltenberg, Secretary-General of the NATO over the phone. During the conversation, the steps to be taken in the fight against the COVID-19 and the post-pandemic period as well as the regional issues, especially Syria and Libya, were discussed.

○ TIKA provided food aid to 5,000 families in need in Iraq.

○ As part of the fight against COVID-19, Turkish Red Crescent donated 19,200 masks to Mauritania.

○ TIKA and Religious Services Consulting Office of the Turkish Embassy in Nur-Sultan provided food aid to the people in need in Kazakhstan on the occasion of Ramadan.

○ Czechia, Bosnia-Herzegovina, North Macedonia, Montenegro, and Bulgaria continued to ease the measures.

## MAY 16

○ President of the Republic of Turkey Recep Tayyip Erdoğan talked to Mustafa al-Kadhimi the new Prime Minister of Iraq over the phone. During the conversation where President Erdoğan expressed his support for Iraq in the fight against the COVID-19 pandemic, bilateral and regional issues were also discussed.

○ The US Federal Reserve (Fed) announced that 39 percent of employees whose household income was below 40,000 Dollars lost their jobs in March due to the novel coronavirus pandemic.

○ The German economy shrank by 2.2 percent in the first quarter of this year compared to the previous quarter due to the novel coronavirus pandemic.

## MAY 17

○ Across the world, the total number of COVID-19 cases reached 4 million 765 thousand 966, the death toll reached 314 thousand 319, and the number of recoveries reached 1 million 842 thousand 690.

# Time Line

**MAY 18**

- President of the Republic of Turkey Recep Tayyip Erdoğan talked to President Vladimir Putin of the Russian Federation over the phone. During the conversation, the opportunities for cooperation on the fight against the coronavirus and the steps to be taken in the post-pandemic period as well as regional issues including Syria in particular and bilateral relations were discussed.
- In his remarks at the opening of the 73rd World Health Assembly, expressing that the novel coronavirus pandemic demonstrated the “global fragility”, the United Nations (UN) Secretary-General Antonio Guterres stated, “We have seen some solidarity, but very little unity, in our response to COVID-19”.
- Tedros Adhanom Ghebreyesus, Director-General of the WHO stated that it would initiate an independent review into its handling of the coronavirus pandemic “at the earliest appropriate moment”.
- In a statement, emphasizing that the economic crisis caused by COVID-19 would not disappear quickly, Portuguese Prime Minister Antonio Costa said, “According to data from the Ministry of Finance, we will not be able to return to the figures in 2019 before 2022, but I am optimistic that if we take the right decisions, there will be an economic recovery”.
- ‘Positive result’ has been achieved in the first phase of the COVID-19 vaccine trial in the USA.
- The Central Bank of Spain warned that the recession in the Spanish economy could be “deeper” than expected because of the coronavirus pandemic.
- The loss of taste and smell was added to the symptoms of COVID-19 in the United Kingdom.

## MAY 19

- US President Donald Trump announced that he would permanently freeze the funds provided to the WHO after 30 days if it did not undertake major substantial reforms.
- Italian Prime Minister Giuseppe Conte stated that they were not prepared for a crisis affecting the whole world, such as the novel coronavirus pandemic.
- The Chief Physician of White House, Sean P. Conley announced that US President Donald Trump started to use hydroxychloroquine as a precautionary measure after one of his aides was diagnosed with the novel coronavirus.
- South Sudan Vice President Riek Machar and his wife Angelina Tang were diagnosed with the novel coronavirus.
- Denmark continued to ease the coronavirus measures.

## MAY 20

- During the month of Ramadan, TIKA provided food aid to 700 families in the poorest regions of the Kingdom of Lesotho, surrounded by the territories of the Republic of South Africa.
- The Ministry of Health of Pakistan announced in a statement that “the highest daily death toll” was recorded in the country.
- The highest increase in the daily number of cases of the novel coronavirus was recorded in India.
- Expressing that the UN General Assembly meetings, which bring together the world leaders every year in September in New York, UN Secretary-General Antonio Guterres suggested that the leaders send video messages as this year it seemed unlikely to hold the meeting due to the novel coronavirus pandemic.

## MAY 21

- Across the world, the death toll caused by COVID-19 reached 331 thousand 459, the total number of cases reached 5 million 135 thousand 691, and the number of recoveries reached 2 million 48 thousand 694.
- Food aid packages prepared by the TIKA Kabul Office to be distributed to 3,000 families, especially suffering from the novel coronavirus pandemic, were delivered to the governorate of Kabul, Afghanistan.
- TIKA provided food aid to those in need in Croatia.
- As part of the fight against the COVID-19 pandemic, the Egyptian government approved the draft law, providing for cuts in the salaries of government officers.
- The Spanish Parliament approved the extension of the state of emergency, which had been imposed due to the COVID-19 pandemic since March 14 and would end on May 24.

# Time Line

## MAY 22

- President of the Republic of Turkey Recep Tayyip Erdoğan talked to President Barham Salih of Iraq and Emir Sheikh Tamim bin Hamad Al Thani of Qatar over the phone. During the conversations, bilateral relations and regional issues, as well as cooperation in the fight against COVID-19 were discussed.
- Turkey and Russia initiated consultations on joint efforts to develop a novel coronavirus vaccine.
- The medical supplies provided by the Turkish Red Crescent, consisting of 100 thousand surgical masks, 20 thousand EN149 masks, 20 thousand protective overalls, 22 thousand protective goggles, medication and five ventilators and disinfectants produced in Turkey, were sent to the Russian Republic of Dagestan, which has been affected by the COVID-19 pandemic.
- TIKA provided food aid to Turkish communities and families in need, living in different parts of Afghanistan, Ukraine, and Lithuania.
- French Economy Minister Bruno Le Maire stated that the French car brand Renault has suffered serious financial problems due to the COVID-19 pandemic and that it might close down altogether.
- US Assistant Secretary for Health Dr. Brett Giroir called on the WHO to urgently launch a global investigation into the COVID-19 pandemic.

## MAY 23

- President of the Republic of Turkey Recep Tayyip Erdoğan and the US President Donald Trump talked over the phone. During the conversation, bilateral relations, as well as COVID-19 and regional developments, particularly Libya and Syria were discussed.
- President of the Republic of Turkey Recep Tayyip Erdoğan and President Shavkat Mirziyoyev of Uzbekistan talked over the phone. During the conversation, Turkey-Uzbekistan relations, cooperation in the fight against COVID-19, and regional developments were discussed.

## MAY 24

- Across the world, the death toll caused by COVID-19 reached 345 thousand 122, the number of cases reached 5 million 457 thousand 202 and the number of recoveries reached 2 million 283 thousand 119.
- President of the Republic of Turkey Recep Tayyip Erdoğan talked to Emir Sheikh Sabah Al-Ahmad Al-Jaber Al-Sabah of Kuwait over the phone. During the conversation, the two leaders congratulated each other on Eid al-Fitr and discussed bilateral relations, regional developments, and cooperation in the fight against COVID-19.
- Turkish Disaster and Emergency Management Presidency (AFAD) distributed 3,000 food parcels to people in need in camps in Idlib before the Eid al-Fitr.

## MAY 25

- Across the world, the number of people infected with COVID-19 reached 5 million 545 thousand 013, the death toll reached 347 thousand 566, while the number of recoveries reached 2 million 324 thousand 728.
- President of the Republic of Turkey Recep Tayyip Erdoğan talked to President Rouhani of Iran, President Alvi of Pakistan, President Berdimuhamedov of Turkmenistan, and President Aliyev of Azerbaijan over the phone.
- EuroLeague and EuroCup 2019-2020 seasons were cancelled due to coronavirus.

## MAY 26

- President of the Republic of Turkey Recep Tayyip Erdoğan talked to President Abdelmadjid Tebboune of Algeria over the phone. During the conversation in which two leaders congratulated each other on Eid al-Fitr, they also discussed mainly the fight against novel coronavirus, as well as bilateral relations and regional issues.
- President of the Republic of Turkey Recep Tayyip Erdoğan talked to President Joko Widodo of Indonesia over the phone. During the conversation in which two leaders congratulated each other on Eid al-Fitr, they also discussed mainly the fight against the novel COVID-19 and the steps aimed at strengthening the bilateral relations.
- As part of Turkey's fight against novel coronavirus, the aircraft carrying aid materials to the African country Chad departed from Ankara.
- The Saudi Arabian administration announced its normalization plan following the measures taken against novel coronavirus.
- UN Deputy Secretary-General Amina Mohammed underlined that many developing and middle-income countries lacked financial instruments for the fight against the COVID-19 and post-pandemic period.

# Time Line

## MAY 27

- Minister of Health of the Republic of Turkey Fahrettin Koca stated that according to data from the Johns Hopkins University, the death toll in Turkey was 2.8 percent, while it was 14.1 percent in Britain, 14.3 percent in Italy, 15.5 percent in France and 5.9 percent in the US as of May 26.
- The food parcels provided by TIKA to be distributed to families in need as part of the fight against COVID-19 and international solidarity were delivered by the Consulate General of Sao Paulo to the Red Cross Sao Paulo Centre.
- The Jerusalem Islamic Foundations Council announced that the Masjid al-Aqsa, which had been closed for over two months due to the novel coronavirus pandemic, would be open to worship on Sunday, May 31.
- President of the EU Commission Ursula von der Leyen stated that the pandemic caused a major economic crisis in Europe and that the European economic model was going through substantial testing.
- While the restrictions imposed in Germany due to COVID-19 created negative effects on many sectors, tourism professionals in Berlin took to the streets and called for a “rescue package” from the government.

## MAY 28

- Across the world, the death toll caused by COVID-19 reached 359 thousand 722, the total number of cases reached 5 million 849 thousand 851 and the number of recoveries reached 2 million 537 thousand 939.
- As part of a study jointly conducted by UNICEF and Save the Children Foundation, it was stressed that the number of children living in poor homes was likely to increase by 86 million to 672 million at the end of 2020 due to the economic devastation caused by COVID-19.

## MAY 29

- Across the world, the number of people infected with COVID-19 exceeded 5 million 955 thousand, the death toll exceeded 363 thousand, while the number of recoveries exceeded 2 million 622 thousand.
- Saudi Arabia announced that the ban on umrah and visits to Masjid al-Haram would continue due to the COVID-19 pandemic.

## MAY 30

- WHO Spokesperson Harris touched upon the medical aid sent by Turkey to more than 80 countries to be used in the fight against coronavirus, saying, "These aids are a good example of solidarity".
- German Ministry of Foreign Affairs thanked Turkey for providing support for the process of discharging its citizens to the country.
- President of the EU Commission Ursula von der Leyen and Representative of the EU for Foreign Relations and Security Policy Josep Borrell called on the US to reconsider its decision to leave the WHO.
- Russian Foreign Ministry Spokesperson Maria Zakharova touched upon the US' decision to leave the WHO, saying, "Washington is damaging the international law with regard to cooperation in the field of health in such a time".

## MAY 31

- Across the world, the number of people infected with COVID-19 reached 6 million 210 thousand 063, the death toll reached 372 thousand 091, while the number of recoveries reached 2 million 770 thousand 326.
- Masjid al-Aqsa in Jerusalem, which had been closed for over two months due to novel coronavirus, reopened to worship.

## JUNE 1

- Many of the measures taken in the TRNC against the novel coronavirus were lifted.
- Kosovo reopened its land borders to all its neighbours.
- Montenegro, which has no active COVID-19 cases, reopened its land borders to its neighbours Bosnia and Herzegovina, Albania, Croatia, and Serbia.
- Bosnia and Herzegovina reopened its land borders to its neighbours Croatia, Serbia, and Montenegro.
- Armenian Prime Minister Nikol Pashinyan and all his family members tested positive for COVID-19.

# Time Line

## JUNE 2

- Across the world, the total number of cases caused by COVID-19 reached 6 million 412 thousand 551, the death toll reached 378 thousand 498, while the number of recoveries reached 2 million 973 thousand 134.

- The restrictions imposed as part of the measures taken against the novel coronavirus pandemic caused a decrease in the daily greenhouse gas emissions by 17.4 percent in Turkey.

## JUNE 3

- With the cooperation of the TIKA and the Turkish Embassy in Nouakchott, 400 families in Mauritania were provided with food and cleaning aid supplies as part of the fight against the COVID-19 pandemic.

- The International Council of Nurses (ICN) reported that at least 230 thousand healthcare professionals across the world were infected with the novel coronavirus and that more than 600 nurses died due to the virus.

- Italy lifted the restrictions imposed on inter-regional travels under the measures against the novel coronavirus and opened its external borders to the EU countries and the countries within the Schengen Area.

- UN Secretary-General Antonio Guterres warned that "Unless we secure significant funding, more than 30 out of 41 aid programmes in Yemen will close in the next few weeks". Guterres underlined the high mortality rate due to novel coronavirus in the city of Aden, where the healthcare system was already on the brink of collapse due to civil war.

## JUNE 4

- Across the world, the number of people infected with COVID-19 reached 6 million 630 thousand 69, the death toll reached 389 thousand 579, while the number of recoveries reached 3 million 201 thousand 540.

- President of the Republic of Turkey Recep Tayyip Erdoğan indicated the following via a video message sent to the "Global Vaccine Summit 2020," held in London:

- The availability of the vaccine to humanity as a whole and its production in adequate quantities for all were as critical as its development,

- Turkey provided medical supplies to 102 countries so far,

## JUNE 5

- As part of our national efforts in the fight against the pandemic, we set up a dedicated platform to conduct vaccine and drug studies, and within this scope, in addition to the private sector and universities, 8 out of the 17 projects under the umbrella of this platform were devoted solely to developing vaccines,
- Turkey already spent more than 75 million Euros for the international assistance and vaccine development initiatives mentioned above.
- Turkey provided medical supplies to Niger as part of the fight against the COVID-19 pandemic.
- Speaking at a joint press conference, Director of the Africa Centres for Disease Control and Prevention Dr. John Nkengasong and AfB Commissioner for Social Affairs Amira Elfadil announced to the public the new strategy aimed at increasing the test capacity in the continent.

- Turkey distributed food packages to 120 families in need in Syria's Tel Abyad district which was cleansed from terror with the Operation Peace Spring.
- Turkish Embassy in Sofia donated 250 medical protective clothing to Bulgarian Red Cross as part of the fight against the novel coronavirus.

## JUNE 6

- Across the world, the number of people infected with COVID-19 reached 6 million 920 thousand 143, the death toll reached 400 thousand 126 while the number of recoveries reached 3 million 388 thousand 223.

# Time Line

## JUNE 7

- Across the world the number of people infected with COVID-19 increased to 7 million 039 thousand 735, the death toll reached 403 thousand 402, and the number of recoveries reached 3 million 442 thousand 559.

## JUNE 8

- The US remained the epicentre of the COVID-19 pandemic and the country with the most casualties worldwide.
- Deputy Foreign Minister of China Ma Zhaoxu announced that they were preparing to gradually open their borders that had been closed to foreigners for a while due to COVID-19.

## JUNE 9

- It was announced that Turkey would donate various aid materials to Afghanistan and Guinea in the fight against the novel coronavirus pandemic.
- Turkey sent medical supplies to the South American country of Paraguay in order to support the fight against the novel coronavirus pandemic.
- WHO stated that transmission of the virus was "very rare" from "asymptomatic" patients who did not show any signs of disease despite carrying COVID-19.
- Spokesperson of the Qatar Supreme Committee for Crisis Management Lolwah Alkhater said that the measures taken to prevent the spread of the pandemic in the country would be lifted gradually.

## JUNE 10

- President of the Republic of Turkey Recep Tayyip Erdoğan talked to President Vladimir Putin of Russia over the phone. During the conversation, the steps to be taken in the fight against the COVID-19 and the post-pandemic period, and bilateral relations as well as the regional issues, including particularly the developments in Libya and Idlib, were discussed.
- Medical assistance truck prepared by Turkey departed from Istanbul to go to the pandemic hospital built in the city of Novi Pazar in Serbia's Sandzak region.
- TIKA distributed hygiene sets to families in need in the capital Juba to support South Sudan in the fight against the novel coronavirus pandemic.

## JUNE 11

- Turkey sent diagnostic kits, ventilators, masks, and drugs to Afghanistan which is struggling with coronavirus with the military cargo aircraft 'Koca Yusuf'.
- The Organization for Economic Cooperation and Development (OECD) released a report containing temporary growth data for G20 countries for the first quarter. It was noted in the OECD report that despite the COVID-19 pandemic, only Turkey's and India's GDP increased among the G20 countries in the first quarter of this year.
- The donation agreement between Turkey and Venezuela aimed to contribute to Venezuela's fight against the coronavirus pandemic and consisting of protective equipment and ventilators was signed.
- No new deaths from COVID-19 had been reported in Spain in the past four days.

## JUNE 12

- Medical materials supplied by TIKA were delivered to the National Centre of Innovative Medicine of Uzbekistan.
- WHO announced that the number of novel coronavirus cases increased by 31 percent in Africa in the last week.
- The fastest increase in the number of COVID-19 cases over the last week was in Mauritania, Ethiopia, South Sudan, and Zimbabwe.

# Time Line

**JUNE 13**

- Leaving behind the UK, Brazil became the country with the highest number of deaths caused by COVID-19 after the USA.
- Norway and Finland, which had closed their borders as part of the fight against COVID-19, decided to completely open their borders to all their neighbours except Sweden as of June 15.

**JUNE 14**

- Across the world, the number of people infected with COVID-19 reached 7 million 930 thousand 273, the death toll reached 433 thousand 634 while the number of recoveries reached 4 million 076 thousand 297.

**JUNE 15**

- Across the world, the number of people infected with COVID-19 reached 8 million 62 thousand 877, the death toll reached 437 thousand 137 while the number of recoveries reached 4 million 173 thousand 441.

## JUNE 16

- President of the Republic of Turkey Recep Tayyip Erdoğan held a meeting with German Chancellor Angela Merkel via video conference. During the meeting, regional issues, including particularly the Eastern Mediterranean and Libya, as well as the fight against the COVID-19, steps to be taken in the post-pandemic period and bilateral relations, were discussed.
- The cargo aircraft carrying medical aid to Sudan, sent by the Turkish Red Crescent to support the fight against COVID-19, arrived at the capital, Khartoum.
- In New Zealand, where the number of cases had been reset with strict measures against the spread of COVID-19, two people tested positive for the virus after 25 days.

## JUNE 17

- Across the world, the number of people infected with COVID-19 reached 8 million 326 thousand 010, the death toll reached 448 thousand 002 while the number of recoveries reached 4 million 356 thousand 750.
- Approximately 356 thousand people were tested due to the increase in novel coronavirus cases in connection with a food market in Beijing, the capital of China. 1255 flights were cancelled from Beijing International Airport and Beijing Daxing International Airport in the capital. People living in the high-risk area, such as the Xinfadi wholesale food market and the surroundings of a nearby market, where the majority of cases in the capital were detected, were prohibited from leaving Beijing.
- The Oscar night in which the most prestigious awards of the world of cinema are given was postponed to April 25, 2021, due to the ongoing pandemic in the USA.

## JUNE 18

- Medical aid was sent by Turkey to Chad for the second time.
- It was announced that novel coronavirus was detected in the Founding President of Kazakhstan, Nursultan Nazarbayev.
- Foreign Minister Mevlüt Çavuşoğlu criticized Germany for including Turkey to the list of 'risky corona zones' together with 130 countries.
- It was announced that five lawmakers from the Iraqi parliament were diagnosed with coronavirus.

# Time Line

**JUNE 19**

- Across the world, the number of people infected with COVID-19 reached 8 million 639 thousand 952, the death toll reached 457 thousand 789 while the number of recoveries reached 4 million 568 thousand 118.

**JUNE 20**

- Across the world, the number of people infected with COVID-19 exceeded 8 million 822 thousand, the death toll exceeded 464 thousand while the number of recoveries exceeded 4 million 662 thousand.
- The state of emergency, declared by Spain on March 14 as a precaution against the COVID-19 pandemic ended at midnight, 98 days later.

**JUNE 21**

- Across the world, the number of people infected with COVID-19 reached 8 million 984 thousand 883, the death toll reached 468 thousand 135 while the number of recoveries reached 4 million 778 thousand 617.
- In China, the clinical trials for the potential COVID-19 vaccine advanced to the second phase.

**JUNE 22**

○ Across the world, the number of people infected with COVID-19 reached 8 million 326 thousand 010, the death toll reached 448 thousand 002 while the number of recoveries reached 4 million 356 thousand 750.

**JUNE 23**

○ President of the Republic of Turkey Recep Tayyip Erdoğan talked to President Moon Jae-in of South Korea over the phone. During the phone conversation, steps to improve bilateral relations and potential areas of cooperation in the fight against the COVID-19 were discussed.

○ WHO announced that more than 183 thousand coronavirus cases were detected yesterday with a record increase worldwide and the virus was still fatal.

○ The men's world number 1 in tennis Serbian Novak Djokovic tested positive for COVID-19.

**JUNE 24**

○ Across the world, the number of people infected with COVID-19 reached 9 million 418 thousand 776, the death toll reached 481 thousand 358 while the number of recoveries reached 5 million 091 thousand 041.

○ President of the Republic of Turkey Recep Tayyip Erdoğan talked to President Vladimir Zelenskiy of Ukraine over the phone. During the phone conversation, bilateral relations and regional issues and the potential areas of cooperation in the fight against the COVID-19 were discussed.

# Time Line

## JUNE 25

- Medical consumables provided by TIKA as part of the fight against the novel coronavirus were delivered to the Governorate of Kabul.
- It was reported that a 114-year-old patient in Ethiopia recovered from the novel coronavirus.
- In the statement made by the British postal service Royal Mail, it was announced that 2 thousand people working in the company's management positions would be laid-off due to the effects of the COVID-19 pandemic.
- The University of Washington Measurement and Evaluation Institute predicted that by October 1, the death toll caused by the COVID-19 pandemic would exceed 179 thousand.
- President of Senegal Macky Sall was quarantined on the suspicion of the novel coronavirus.
- Australia's national airline company Qantas announced that it would lay off 6 thousand personnel in order to avoid the effects of the COVID-19 pandemic.
- The UN noted that 25 percent of confirmed cases of the novel coronavirus in Yemen, where the world's worst humanitarian crisis had occurred, died and warned the international community that if there was no help, they would "watch Yemen fall off the cliff".

## JUNE 26

- Across the world, the number of people infected with COVID-19 reached 9 million 796 thousand 64, the death toll reached 493 thousand 870 while the number of recoveries reached 5 million 299 thousand 275.
- Turkey sent mask aid to the Republic of San Marino, affected by the novel coronavirus pandemic.
- The United Arab Emirates sent 100,000 diagnostic kits to Israel within the scope of cooperation in the fight against COVID-19.

## JUNE 27

- Across the world, the number of people infected with COVID-19 reached 9 million 992 thousand 306, the death toll reached 498 thousand 813 while the number of recoveries reached 5 million 410 thousand 258.
- Serbian Defence Minister Aleksandar Vulin and Parliament Speaker Maja Gojkovic were reported to have tested positive for the COVID-19.

## JUNE 28

- President of the Republic of Turkey Recep Tayyip Erdoğan talked to Prime Minister Ersin Tatar of the Turkish Republic of Northern Cyprus (TRNC) over the phone. During the phone conversation between Erdoğan and Tatar, bilateral relations and regional issues, as well as the steps to be taken for cooperation in the fight against the novel coronavirus, were discussed.
- The agreement signed between Turkey and the WHO regarding the establishment of the World Health Organization's "Regional Office for Humanitarian and Health Emergencies Preparedness" in Istanbul was ratified and published in the Official Gazette.

## JUNE 29

- Across the world, the number of people infected with COVID-19 exceeded 10 million 329 thousand, the death toll exceeded 505 thousand while the number of recoveries exceeded 5 million 602 thousand.
- President Recep Tayyip Erdoğan talked to President Gurbanguly Berdimuhamedov of Turkmenistan over the phone.
- Turkey announced that it would send medical aid materials to Iraq, which is fighting against the novel coronavirus.
- It was reported that the COVID-19 vaccine, which was in the phase of human clinical trials in China, started to be used in the People's Liberation Army of China.

# Time Line

## JUNE 30

- TIKA provided medical equipment and hygiene materials to the South Sudan Ministry of Health to support the fight against the COVID-19 pandemic in South Sudan.
- Turkey announced that it would send aid to the Sandzak region in Serbia, where serious hardship was being experienced due to the novel coronavirus pandemic.
- Clinical trials began for the first potential vaccine against the novel coronavirus in Japan.
- The EU, which closed its borders in March due to the novel coronavirus, announced that it would lift travel restrictions to 14 countries as of July 1.
- Uzbekistan decided to re-impose certain measures as of July 1, since the daily number of cases of novel coronavirus increased significantly.
- Due to the increase in cases of the novel coronavirus, Britain decided to close commercial businesses and schools in Leicester, and not to take steps to ease the measures.

## JULY 2

- President of the Republic of Turkey Recep Tayyip Erdoğan talked to German Chancellor Angela Merkel over the phone. During the conversation, cooperation in the fight against COVID-19 and bilateral relations were discussed.
- Turkey announced that it would provide Namibia with 30 thousand N95 masks, 60 thousand tree-ply masks, and 20 thousand protective overalls as a gesture of goodwill in line with the ratified "Agreement between the Government of the Republic of Turkey and the Government of the Republic of Namibia on donation in the field of health".
- Inovio, a US pharmaceutical company, reported that the potential vaccine it developed against the novel coronavirus obtained promising results from clinical trials in the first phase.

## JULY 3

Across the world, the number of people infected with COVID-19 reached 11 million 083 thousand 967, the death toll reached 526 thousand 310 while the number of recoveries reached 6 million 208 thousand 623.

Britain announced that passengers from Turkey would be exempt from the 14-day isolation requirement.

WHO announced that the novel coronavirus cases seen in the African continent increased by 28 percent in a week.

## JULY 4

Across the world, the number of people infected with COVID-19 exceeded 11 million 280 thousand, the death toll exceeded 530 thousand while the number of recoveries exceeded 6 million 390 thousand.

Turkish military aircraft carrying medical aid supplies to Serbia, affected by the novel coronavirus pandemic, departed from Ankara. Turkey, for the second time, sent masks, domestically produced ventilators, face-shields, protective overalls and goggles to Serbia, to support its fight against COVID-19.

## JULY 5

WHO announced that they would discontinue the trials of the medicines "hydroxychloroquine" and "lopinavir/ritonavir" used in the treatment of COVID-19 patients, as trial results showed "little or no reduction in the mortality rate".

Foreign Minister Mevlüt Çavuşoğlu stated that they successfully carried out the largest evacuation operation in the history of the Republic during the novel coronavirus period and said, "We have brought more than 90 thousand of our citizens from 130 countries to our country".

The medical supplies Turkey sent to Azerbaijan, in order to contribute to the fight against the novel coronavirus, arrived in Baku. Aid materials sent to Azerbaijan included 30 ventilators, 55 thousand overalls, 50 thousand N95 masks, 100 thousand surgical masks, 5 thousand goggles, 200 thousand gloves, and 40 thousand boxes of various medications.

The US remained the epicentre of the COVID-19 pandemic and the country where the largest number of casualties had been reported.

# Time Line

## JULY 6

- TIKA provided medical equipment and hygiene materials to the South Sudan Ministry of Health to support the fight against the COVID-19 pandemic in South Sudan.
- Turkey announced that it would send aid to the Sandzak region in Serbia, where serious hardship was being experienced due to the novel coronavirus pandemic.
- Clinical trials began for the first potential vaccine against the novel coronavirus in Japan.
- The EU, which closed its borders in March due to the novel coronavirus, announced that it would lift travel restrictions to 14 countries as of July 1.
- Uzbekistan decided to re-impose certain measures as of July 1, since the daily number of cases of novel coronavirus increased significantly.
- Due to the increase in cases of the novel coronavirus, Britain decided to close commercial businesses and schools in Leicester, and not to take steps to ease the measures.

## JULY 7

- While the number of people diagnosed with Covid-19 exceeded 11 million 815 thousand, the death toll reached 542 thousand whereas more than 6 million 796 thousand people recovered worldwide.
- President Recep Tayyip Erdoğan held a phone conversation with Kazakhstan's founding President Elbasy Nursultan Nazarbayev. During the conversation, the steps to strengthen the relations and regional cooperation between the two countries and the common struggle against Covid-19 were discussed.
- Brazilian President Jair Bolsonaro was diagnosed with the novel coronavirus.
- As a result of the increasing number of cases and deaths in Serbia in recent days, it was stated that gathering of more than 5 people was banned, and a lockdown would be applied over the weekend.
- While all football matches were suspended in Montenegro, the 'state of pandemic was declared in 5 cities where the number of cases increased.

## JULY 8

◉ With the confirmation of Covid-19 in 191 people in Melbourne, Australia, it was announced that lockdown would be implemented for 6 weeks, except for compelling reasons.

◉ It was noted that there would be no employment of public personnel for 2 years due to Covid-19 in Indonesia.

◉ State Minister Yaw Osafo Mafo in Ghana was diagnosed with Covid-19.

◉ After the countries eased their measures against Covid-19 for economic reasons, there has been a serious increase in the number of cases especially as of June, particularly in Iran, Saudi Arabia, Iraq, the United Arab Emirates, Egypt, Israel, and Palestine.

◉ British Ambassador to Ankara, Dominick Chilcott said: "Considering Turkey's success in keeping under control the virus so far, and after observing that how rigorous the Safe Tourism Certification Program is implemented, we removed our recommendation to not travel to Turkey. Now, we will no longer impose 14 days quarantine on people arriving in England from Turkey."

◉ The African Development Bank (AfDB) indicated that the novel coronavirus pandemic could channel nearly 49 million Africans into extreme poverty.

◉ President of Kazakhstan Kassym-Jomart Tokayev declared July 13 as the day of national mourning for those who lost their lives due to Covid-19.

◉ The Interagency Coordination Council of the Georgian Government allowed citizens of Germany, France, Latvia, Lithuania, and Estonia to enter the country by airways.

◉ In Nigeria, 3,789 prisoners were pardoned as part of the Covid-19 measures.

# Time Line

## JULY 9

- The number of people diagnosed with Covid-19 worldwide was reported as 12 million 268 thousand 096, while the death toll reached 554 thousand 348, whereas 7 million 127 thousand 651 people recovered worldwide.
- Brazilian President Jair Bolsonaro vetoed the relevant provisions of the law, which obligated the provision of Covid-19 aid for the indigenous people in the country.
- As a measure against the pandemic, China cancelled all sports events in 2020, apart from national trials for the Winter Olympics to be held in the capital city Beijing and Zhangjiakou in 2022.
- In the Republic of South Africa, the country with the highest cases of Covid-19 in the African continent, state governments began to build mass graves for those who lost their lives due to the coronavirus.
- Senegal Football Federation ended the season in football leagues that were interrupted in March due to the pandemic.

## JULY 10

- While the number of cases reached 12 million 509 thousand, the death toll approached 560 thousand worldwide.
- Jeanine Anez, who was appointed as the interim president of Bolivia, announced that she was diagnosed with the coronavirus.
- Brazilian President Jair Bolsonaro called for the reopening of businesses, which were closed as part of measures to fight against Covid-19.
- WHO Director-General Tedros Adhanom Ghebreyesus declared that a delegation of experts within the organization departed for China to investigate the source of the pandemic.
- The Belgian government announced that the use of masks was made obligatory in closed spaces as of tomorrow.
- Moldovan Prime Minister Ion Kiku declared that they had decided to extend the state of emergency in the field of health in the country until July 31.

## JULY 11

- It was stated that as of today, the inter-city travels with public transport vehicles were prohibited in Uzbekistan where domestic flights and train services would be suspended temporarily as of July 13.
- The African Union announced the establishment of a new consortium for clinical trials of the Covid-19 vaccine.
- In Namibia, the first death was recorded due to Covid-19.
- The schools opened in Nigeria after 3 months due to Covid-19 were closed again due to the increasing cases.
- Sudan announced that the air traffic which was suspended within the framework of the Covid-19 measures
- The number of people diagnosed with Covid-19 reached 12 million 735 thousand, the death toll reached 565 thousand whereas over 7 million 435 thousand people recovered worldwide.
- The Supreme Election Board of Spain banned those whose Covid-19 tests were positive in the autonomous regions of Galicia and Basque to go to the polls on Sunday's voting.
- Even though Covid-19 cases exceeded 31,000 in Nigeria, domestic flights were launched in 7 states.
- President of Argentine Alberto Fernandez announced that the Covid-19 vaccine candidate would be tested on people in his country.
- Central African country, Chad announced that it would lift the international flight ban that it implemented within the scope of the measures in early August.
- In Uzbekistan, a traffic ban was imposed on vehicles at the weekends until the end of July. As part of the measures, people over the age of 65 were prohibited from going out until the end of July.

# Time Line

## JULY 12

- The number of people diagnosed with Covid-19 reached 12 million 952 thousand 440, the death toll reached 569 thousand 499 whereas 7 million 547 thousand 450 people recovered worldwide.
- After Covid-19 was confirmed in US military personnel in the Okinawa state of Japan, it was reported that 2 military bases on the island were quarantined.
- Doctors without Borders announced that some healthcare workers in Yemen quitted because of Covid-19.

## JULY 13

- The number of people diagnosed with Covid-19 reached 13 million 84 thousand 739, the death toll reached 572 thousand 554 whereas 7 million 625 thousand 376 people recovered worldwide.
- Kudret Özersay, Deputy Prime Minister and Minister of Foreign Affairs of the TRNC stated that the Greek Cypriot side was applying new restrictions that were not related to the pandemic for some time at the border crossings. Özersay noted that since July 1 they had told the UN and EU interlocutors that those new restrictions were not related to the pandemic and that they aimed to harm the Turkish Cypriot economy.
- The Palestinian government announced the extension of the overall quarantine implementation in 4 cities in the occupied West Bank as part of the Covid-19 measures.
- The Covid-19 measures implemented in the Republic of South Africa, where most cases of Covid-19 were observed in Africa, were extended until August 15.
- In Armenia, it was decided to extend the state of emergency, which continued from March 16 until August 12.
- In Kazakhstan, it was reported that the 14-day quarantine, launched on July 5, would be extended for another 2 weeks, due to the continued increase in the number of cases.

**JULY 14**

- The number of people diagnosed with Covid-19 exceeded over 13 million 341, the death toll reached 577 thousand whereas over 7 million 778 thousand people recovered worldwide.
- TIKA provided medical supplies in the fight against Covid-19 in the occupied East Jerusalem.
- It was reported that as of July 24, it would be mandatory to wear a mask at the markets within the scope of the fight against Covid-19 in the UK.
- Secretary-General of Turkic Speaking Countries Cooperation Council Baghdad Amreyev stated that Turkey was always there for the brotherly Turkic States in the fight against the Covid-19 and provided assistance to the countries in need around the world.
- Clinical trials of two new Covid-19 vaccine candidates began in Australia and Canada.
- Singapore and Malaysia decided to partially initiate border crossings closed due to the Covid-19 outbreak on August 10.
- The decision to keep the US-Canada border closed for non-compulsory crossings due to the pandemic was extended until August 21.
- The 2020 Chicago Marathon, scheduled for October, was cancelled due to the pandemic.
- Saudi Arabian authorities noted that it was forbidden to perform the Eid al-Adha prayer in open areas within the framework of the Covid-19 measures.

# Time Line

## JULY 15

- It was reported that the first potential Covid-19 vaccine, which was started to be tested on people in the US, reached the final phase.
- Mexico and the United States decided to close their borders to non-compulsory crossings till August 21 as the novel coronavirus cases increased in these countries.
- A lockdown was declared in many states as the number of cases in India approached one million.
- Italian Prime Minister Giuseppe Conte stated that there had to be an agreement this month on the rescue fund, which was brought up in the EU, to tackle the effects of the Covid-19 pandemic on the economy.
- Radovan Viskovic, Prime Minister of Republika Srpska, one of the two entities of Bosnia and Herzegovina, was tested Covid-19 positive.
- Jordan Ministry of Education announced that education in schools would start in September considering the spread of the pandemic in the country.
- The ban on travelling abroad, which was implemented under the Covid-19 measures in Oman, was lifted after 4 months.

## JULY 16

- The number of people diagnosed with Covid-19 worldwide reached 13 million 806 thousand 174, the death toll reached 589 thousand 181 whereas 8 million 214 thousand 297 patients recovered worldwide.
- Britain accused the Russian intelligence of stealing information from institutions conducting the work on developing a vaccine against novel coronavirus.
- The EU countries, which sealed borders in March due to novel coronavirus, removed Montenegro and Serbia from the list of countries from which non-compulsory travel is allowed.
- It was reported that the prospective Covid-19 vaccine, developed by a biotechnology firm in Germany in which Turkish scientist Prof. Uğur Şahin was the co-founder, had been started to be tested on humans in Germany and the US, and then China.
- The prospective Covid-19 vaccine started to be tested on humans in India.

## JULY 17

- A 23-day baby died due to novel coronavirus in the south-western state of Bushehr in Iran.
- The Iraqi government decreased the hours of partial lockdown, which has been practiced due to novel coronavirus, and decided to reopen the airports and shopping centres, which had been closed for a while.
- While the race to develop a vaccine against novel coronavirus continued, it was revealed that some employees, including senior managers of a Chinese company, had been applied an experimental vaccine, which was yet to be confirmed for testing on humans.
- IMF reported that a new stage of the Covid-19 pandemic started and that the global economic activity started to recover from a much lower level.
- American Airlines, the US airline company, reported that it was likely to send notices of furlough to its 25,000 employees due to the economic impacts of the novel coronavirus pandemic.
- The number of cases exceeded 14 million worldwide.
- The UN called for the largest humanitarian aid in its history, raising its call for aid to 10.3 billion American dollars in order to support vulnerable and low-income countries in the fight against the pandemic.
- The IMF predicted that the US economy would shrink by 6.6 percent this year due to the pandemic.
- The leaders of 27 EU member states met in Brussels to discuss the future budget along with the rescue fund prepared to combat the economic consequences of the novel coronavirus.
- Due to the increasing number of cases, the Federation of Bosnia Herzegovina, one of the two entities of Bosnia Herzegovina, declared a "state of pandemic".
- It was decided to extend the quarantine implementation in Azerbaijan until August 31. As per the decision, it was noted that the lockdown would continue to be implemented until August 5 in 14 regions, including the capital Baku.
- The United Nations Latin American and Caribbean Economic Commission reported that the economies of the countries in the region were expected to shrink by 9.1 percent in 2020 due to the novel coronavirus pandemic.

# 14 Rules against the Risk of Coronavirus

1

Wash your hands frequently with water and soap by rubbing for at least 20 seconds.

2

Keep a distance of at least 3-4 steps from another person with symptoms of a cold.

3

Cover your nose and mouth with a disposable tissue when you cough or sneeze. If you don't have a tissue, cough or sneeze into your elbow.

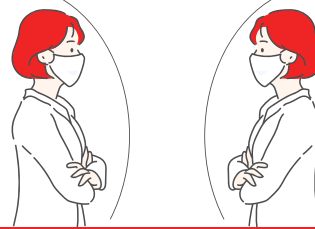
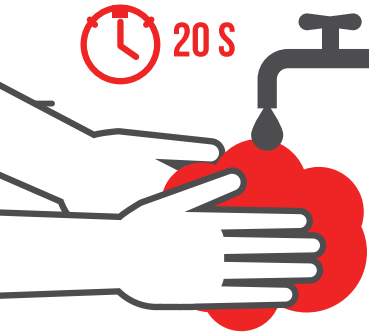

Ventilate indoors frequently.

Wash your clothes at a temperature of 60-90°C with normal detergent.

Clean the frequently used surfaces such as doorknobs, fittings, and washbasins with water and detergent every day.

8

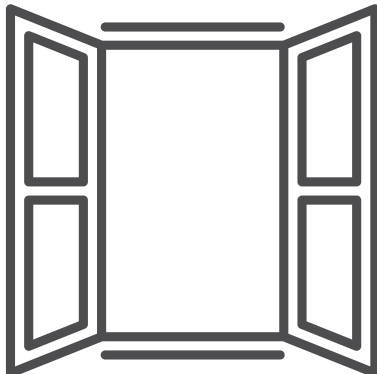

9

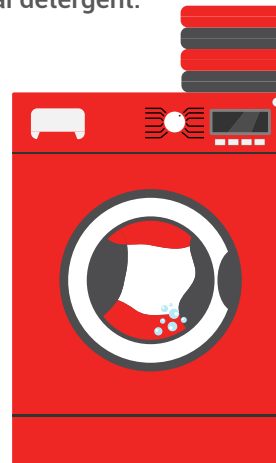

10



4

Avoid close contacts like shaking hands and hugging.



5

Do not touch your eyes, mouth, and nose with your hands.



6

Cancel or postpone your travels abroad.



7

Spend your first 14 days at home after your return from abroad.



Avoid contact with the elderly or those with chronic diseases if you have signs of cold, wear a mask while going outside.



11

Do not share personal belongings such as towels.



12

Drink lots of liquid, keep a balanced diet, and pay attention to your sleeping pattern.



13

If you suffer from a persistent fever, cough, and shortness of breath, apply to a healthcare institution after wearing a mask.



14

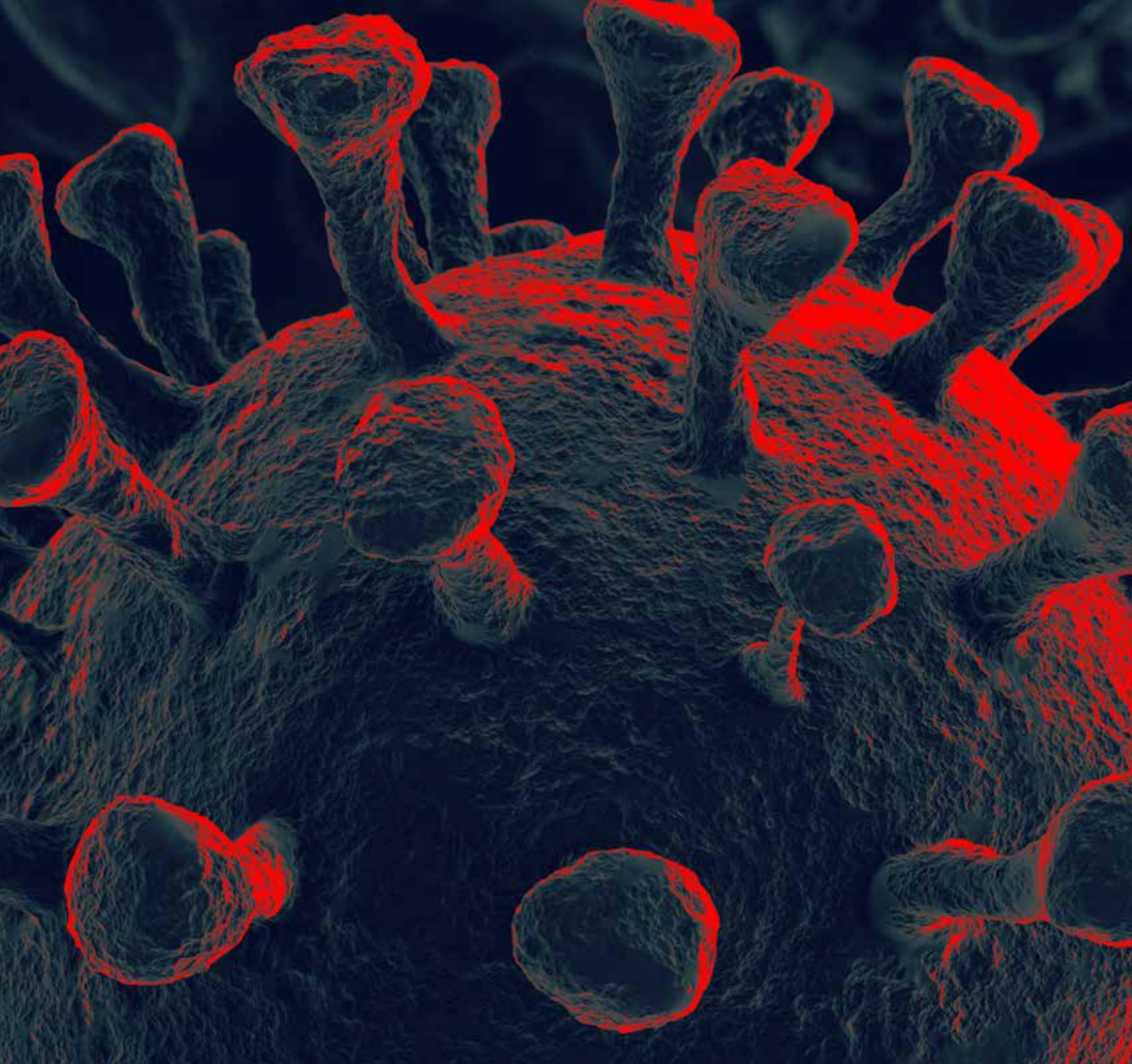



**COVID-19 ACROSS THE WORLD  
AND IN TURKEY**

# Covid-19 Across the World and in Turkey

## General Outlook across the World

The novel coronavirus that broke out in Wuhan, the capital of Hubei province in China, has spread across 215 countries of the world to the present day (July 17, 2020). Across the world, 14 million 297 thousand 640 people have been diagnosed with Covid-19, 9 million 172 thousand 244 people have recovered and 594 thousand 214 people lost their lives. The map and graph below show in detail the countries and the number of people affected by the disease by date.



■ Countries with fatalities

COVID-19 ACROSS THE WORLD

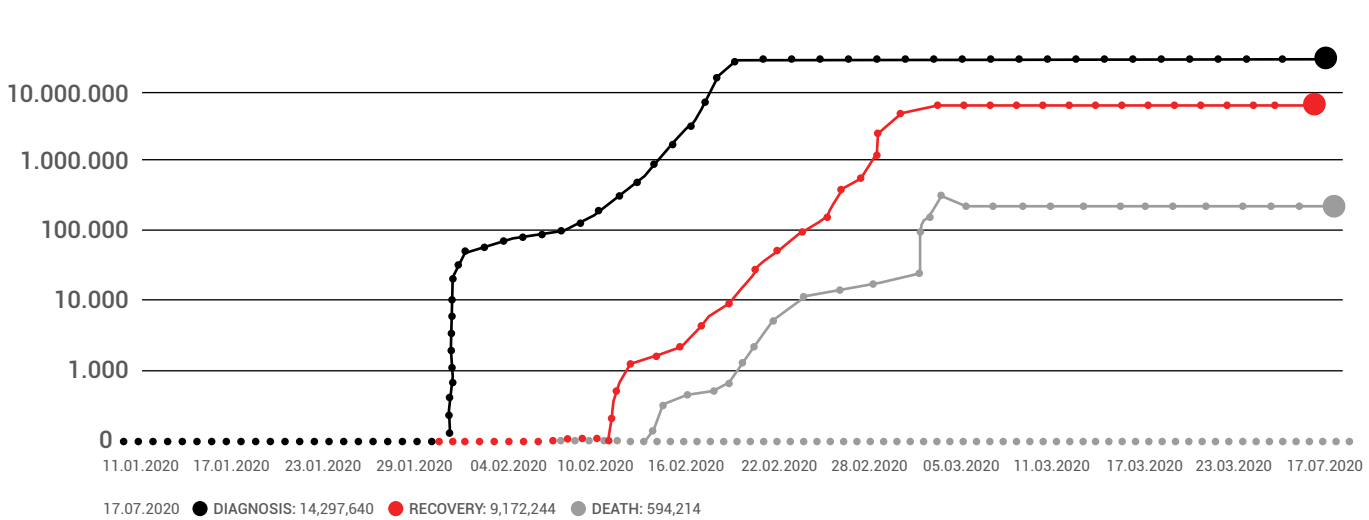

Countries are affected to varying degrees by the pandemic, which should be assessed according to multiple parameters including total population, the number of tests and confirmed cases, the capacity of healthcare services, and the scope of enforced measures. The top five countries with the highest death toll are the USA, Brazil, India, Russia, and the South Africa respectively. USA (3,692,222) tops the list of countries with the highest number of cases, followed by Brazil (2.155.263), India (1.574.527), Russia (633.784).

# Covid-19 Across the World and in Turkey

The table below shows the top 10 countries with the highest number of cases listed by the number of confirmed cases.

## COUNTRIES WITH THE HIGHEST NUMBER OF CASES IN THE WORLD

<b>COUNTRY</b>	<b>DEATH / DIAGNOSOS:</b> 3,66%	<b>DIAGNOSIS:</b> 20,059,350	<b>DEATH:</b> 734,635
UNITED STATES OF AMERICA	3,18%	3,692,222	117,589
BRAZIL	3,33%	2,155,263	71,806
INDIA	2,00%	1,574,527	31,594
RUSSIA	1,68%	633,784	10,650
SOUTH AFRICA	1,85%	397,499	7,389
MEXICO	10,88%	340,997	37,131
PERU	4,40%	339,397	14,961
COLOMBIA	3,31%	275,111	9,117
CHILE	2,70%	264,869	7,154
SPAIN	7,88%	256,623	20,237



# Covid-19 Across the World and in Turkey



### Covid-19 Outlook in Turkey

With the measures taken, Turkey managed to prevent the entry of coronavirus into our country for a long time. The first case in Turkey was detected on March 11, 2020. In view of the cases diagnosed in countries like China, Italy, and Spain in January, Turkey diligently monitored and assessed the course of the pandemic in other countries and swiftly enforced comprehensive measures.

As of July 17, 2020, a total of 217 thousand 799 people were diagnosed with Covid-19, 199 thousand 834 patients recovered and 5 thousand 458 citizens lost their lives. The graphs below show the coronavirus statistics in our country by date.

#### COVID-19 IN TURKEY

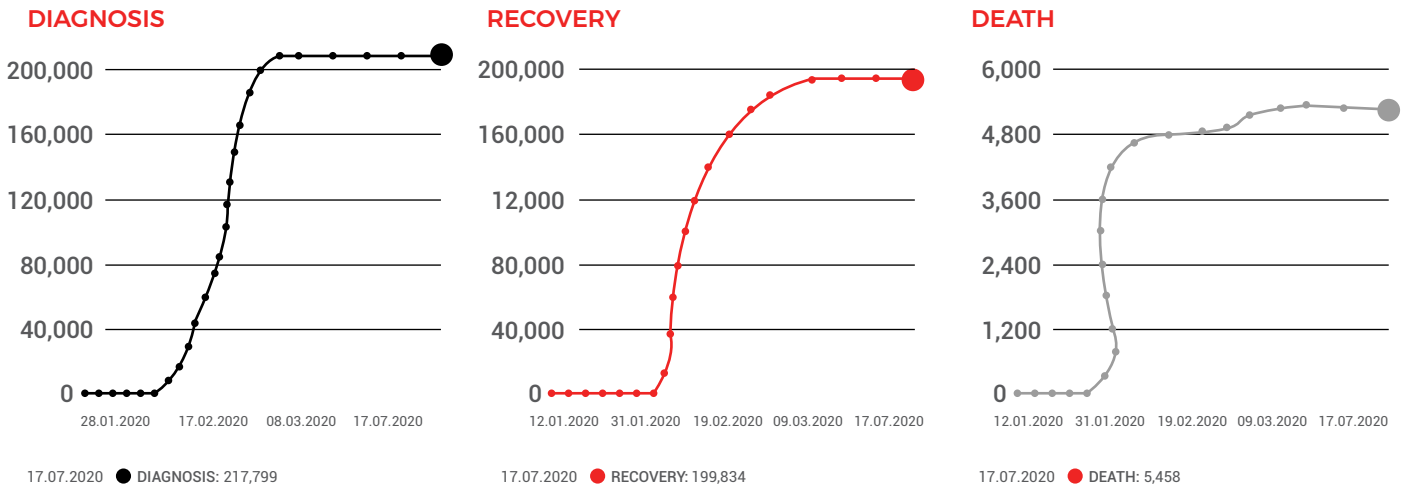

# Covid-19 Across the World and in Turkey

As of July 17, 2020, a total of 4.191.124 tests were conducted in Turkey and the number of cases reached 217 thousand 799. The Diagnosis-to-death ratio in Turkey is 2.50%.

## TABLE OF DAILY CORONAVIRUS FIGURES IN TURKEY

17 JULY 2020

TOTAL NUMBER OF TESTS	TOTAL NUMBER OF CASES	TOTAL NUMBER OF DEATHS	TOTAL NUMBER OF INTENSIVE CARE PATIENTS	TOTAL NUMBER OF ENTUBATED PATIENTS	TOTAL NUMBER OF RECOVERIES
4.191.124	217.799	5.458	1.226	402	199.834
			NUMBER OF TESTS TODAY	NUMBER OF CASES TODAY	NUMBER OF DEATHS TODAY
			41.215	926	18



**It is possible to say that measures swiftly taken and implemented by Turkey in the early period have proven quite effective. Turkey is currently better off than other countries in terms of both the number of cases and the total death toll.**

**CURRENT CORONAVIRUS SITUATION ACROSS THE WORLD**

17 JULY 2020

COUNTRY	TOTAL CASES	TOTAL DEATHS	TOTAL DISCHARGES
TURKEY	217,799	5,458	199,834
UNITED STATES OF AMERICA	3,692,222	117,589	1,892,118
BRAZIL	2,155,263	71,806	1,504,106
INDIA	1,574,527	31,594	1,090,743
RUSSIA	633,784	10,650	494,016
SOUTH AFRICA	397,499	7,389	292,146
MEXICO	340,997	37,131	228,950
PERU	339,397	14,961	230,054
COLOMBIA	275,111	9,117	151,008
CHILE	264,869	7,154	245,536

ACROSS THE WORLD  
**14,297,640+**  
 PEOPLE WERE  
 INFECTED

ACROSS THE WORLD  
**594,214+**  
 PEOPLE LOST  
 THEIR LIVES

ACROSS THE WORLD  
**9,172,244+**  
 PEOPLE RECOVERED





**DEVELOPMENT OF HEALTHCARE  
SERVICES IN TURKEY:  
2002-2020 PERIOD**

# Development of Healthcare Services in Turkey: 2002-2020 Period

Healthcare has been one of the main policy fields that Turkey has particularly centred since 2002. Major reforms have been undertaken to provide the citizens with better quality healthcare services and to restructure the healthcare sector, and important achievements have been made at the global level. Over the period in question, significant progress has been made both in terms of access to healthcare services and in relation to each of the health indicators. Thanks to leaps in the field of healthcare, Turkey has climbed up in international healthcare indices and has also become an exemplary country on a global scale.

In the 2002-2020 period, besides many projects aimed at offering better quality healthcare services to citizens such as the "Central Physician Appointment System", "SABIM", "e-Pulse Individual Health System" under the roof of "Transformation in Healthcare", important strides have been made in the fields of healthcare infrastructure, healthcare professionals and hospitals.

In times of such a rapidly spreading pandemic like Covid-19 around the world, healthcare infrastructure, healthcare professionals, and the capacity of hospitals, in particular, become even more prominent, as agreed by all experts on the matter.



**The aforementioned healthcare investments in the 2002-2020 period have significantly bolstered the strength of our country in terms of battling and responding to this global pandemic.**

## Development of Healthcare Services in Turkey: 2002-2020 Period

In this context, the graphs and tables below show in detail the distance covered by Turkey in the last 18 years and the current position of the country as regards to the leading health indicators in the event of a pandemic.

### NUMBER OF HOSPITAL BEDS BY YEAR AND SECTOR

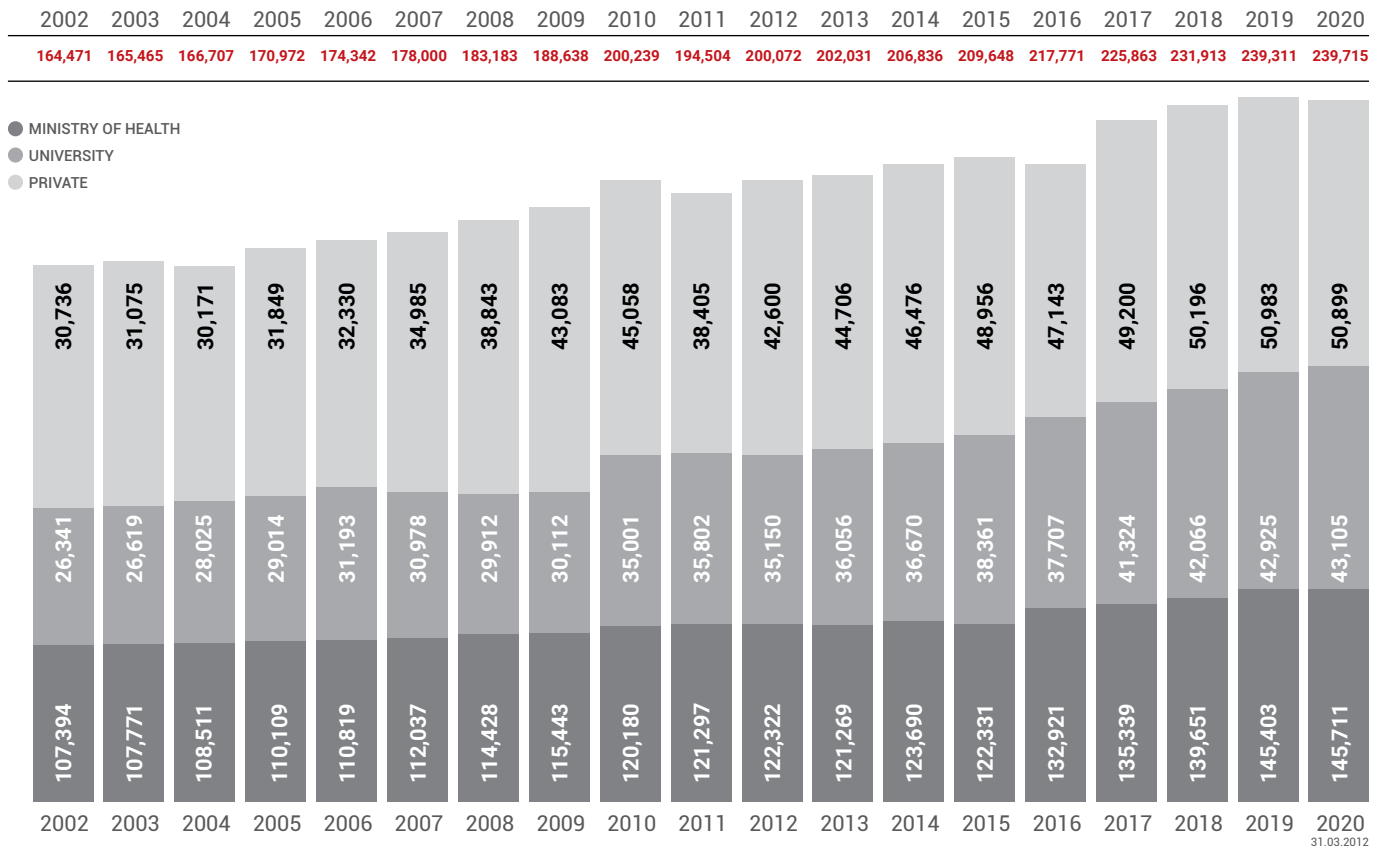

# Development of Healthcare Services in Turkey: 2002-2020 Period

While the number of hospital beds in Turkey was 164,471 in 2002, this number rose to 239,715 by 31.03.2020.

## NUMBER OF INTENSIVE CARE BEDS IN TURKEY

Number of Intensive Care Beds by Year, Sector, Level and Type																					
Year	Sector	Neonatal Intensive Care					Pediatric Intensive Care				Adult Intensive Care				Total Intensive Care						
		PRIMARY	SECONDARY	TERTIARY	Quaternary A	Quaternary B	TOTAL	PRIMARY	SECONDARY	TERTIARY	TOTAL	PRIMARY	SECONDARY	TERTIARY	TOTAL	PRIMARY	SECONDARY	TERTIARY	Quaternary A	Quaternary B	TOTAL
2002	Ministry of Health																				869
	University																				353
	Private																				992
	<b>TOTAL</b>																				<b>2.214</b>
2008	Ministry of Health	505	801	404			1.710					2.060	1.478	1.173	4.711	2.565	2.279	1.577			6.421
	University	53	71	463			587				319	401	1.821	2.541	372	472	2.284				3.128
	Private	574	473	373			1.420				1.202	920	874	2.996	1.776	1.393	1.247				4.416
	<b>TOTAL</b>	<b>1.132</b>	<b>1.345</b>	<b>1.240</b>			<b>3.717</b>				<b>3.581</b>	<b>2.799</b>	<b>3.868</b>	<b>10.248</b>	<b>4.713</b>	<b>4.144</b>	<b>5.108</b>				<b>13.965</b>
2012	Ministry of Health	844	1.190	1.080			3.114	37	259	176	472	2.295	2.352	2.088	6.735	3.176	3.801	3.344			10.321
	University	106	209	629			944	28	102	242	372	500	634	1.786	2.920	634	945	2.657			4.236
	Private	1.093	773	1.602			3.468	7	8		15	1.966	1.371	2.312	5.649	3.066	2.152	3.914			9.132
	<b>TOTAL</b>	<b>2.043</b>	<b>2.172</b>	<b>3.311</b>			<b>7.526</b>	<b>72</b>	<b>369</b>	<b>418</b>	<b>859</b>	<b>4.761</b>	<b>4.357</b>	<b>6.186</b>	<b>15.304</b>	<b>6.876</b>	<b>6.898</b>	<b>9.915</b>			<b>23.689</b>
2015	Ministry of Health	916	1.207	1.241			3.364		289	352	641	2.259	3.292	2.986	8.537	3.175	4.788	4.579			12.542
	University	112	248	844			1.204		147	361	508	510	806	2.344	3.660	622	1.201	3.549			5.372
	Private	975	891	3.964			5.830		28	26	54	1.337	1.949	4.399	7.685	2.312	2.868	8.389			13.569
	<b>TOTAL</b>	<b>2.003</b>	<b>2.346</b>	<b>6.049</b>			<b>10.398</b>		<b>464</b>	<b>739</b>	<b>1.203</b>	<b>4.106</b>	<b>6.047</b>	<b>9.729</b>	<b>19.882</b>	<b>6.109</b>	<b>8.857</b>	<b>16.517</b>			<b>31.483</b>
2016	Ministry of Health	959	1.247	1.379			3.585		312	404	716	2.406	3.543	3.375	9.324	3.365	5.102	5.158			13.625
	University	131	247	854			1.232		88	365	453	505	916	2.314	3.735	636	1.251	3.533			5.420
	Private	976	681	4.465			6.122		5	33	38	1.221	2.044	4.593	7.858	2.197	2.730	9.091			14.018
	<b>TOTAL</b>	<b>2.066</b>	<b>2.175</b>	<b>6.698</b>			<b>10.939</b>		<b>405</b>	<b>802</b>	<b>1.207</b>	<b>4.132</b>	<b>6.503</b>	<b>10.282</b>	<b>20.917</b>	<b>6.198</b>	<b>9.083</b>	<b>17.782</b>			<b>33.063</b>
2017	Ministry of Health	967	1.374	1.496			3.837		365	536	901	2.360	3.904	3.994	10.258	3.327	5.643	6.026			14.996
	University	163	249	974			1.386		135	421	556	345	989	2.589	3.923	508	1.373	3.984			5.865
	Private	1.220	929	4.614			6.763		13	56	69	1.242	2.275	5.030	8.547	2.462	3.217	9.700			15.379
	<b>TOTAL</b>	<b>2.350</b>	<b>2.552</b>	<b>7.084</b>			<b>11.986</b>		<b>513</b>	<b>1.013</b>	<b>1.526</b>	<b>3.947</b>	<b>7.168</b>	<b>11.613</b>	<b>22.728</b>	<b>6.297</b>	<b>10.233</b>	<b>19.710</b>			<b>36.240</b>
2018	Ministry of Health	987	1.451	1.428	78	30	3.974		370	571	941	2.488	4.123	4.560	11.171	3.475	5.944	6.559	78	30	16.086
	University	157	260	997	34		1.448		106	436	542	311	1.036	2.702	4.049	468	1.402	4.135	34		6.039
	Private	1.240	1.110	4.630			6.980		60	82	142	1.404	2.485	4.962	8.851	2.644	3.655	9.674			15.978
	<b>TOTAL</b>	<b>2.384</b>	<b>2.821</b>	<b>7.055</b>	<b>112</b>	<b>30</b>	<b>12.402</b>		<b>536</b>	<b>1.089</b>	<b>1.625</b>	<b>4.203</b>	<b>7.644</b>	<b>12.224</b>	<b>24.071</b>	<b>6.587</b>	<b>11.001</b>	<b>20.368</b>	<b>112</b>	<b>30</b>	<b>38.098</b>
2019	Ministry of Health	1.019	1.556	1.691	134	30	4.430		392	718	1.110	2.556	4.587	5.360	12.503	3.389	6.388	7.077	134	30	17.018
	University	149	257	958	49	30	1.443		103	485	588	352	985	2.831	4.168	515	1.375	4.248	49	30	6.217
	Private	1.414	1.219	4.575			7.208		53	94	147	1.438	2.565	5.099	9.102	2.671	3.742	9.663			16.076
	<b>TOTAL</b>	<b>2.582</b>	<b>3.032</b>	<b>7.224</b>	<b>183</b>	<b>60</b>	<b>13.081</b>		<b>548</b>	<b>1.297</b>	<b>1.845</b>	<b>4.346</b>	<b>8.137</b>	<b>13.290</b>	<b>25.773</b>	<b>6.575</b>	<b>11.505</b>	<b>20.988</b>	<b>183</b>	<b>60</b>	<b>39.311</b>
2020	Ministry of Health	1.038	1.510	1.524	134	30	4.236		394	645	1.039	2.463	4.580	5.245	12.288	3.501	6.484	7.414	134	30	17.563
	University	143	259	993	49	30	1.474		103	491	594	367	994	2.879	4.240	510	1.356	4.363	49	30	6.308
	Private	1.392	1.238	4.395			7.025		73	92	165	1.391	2.455	5.087	8.933	2.783	3.766	9.574			16.123
	<b>TOTAL</b>	<b>2.573</b>	<b>3.007</b>	<b>6.912</b>	<b>183</b>	<b>60</b>	<b>12.735</b>		<b>570</b>	<b>1.228</b>	<b>1.798</b>	<b>4.221</b>	<b>8.029</b>	<b>13.211</b>	<b>25.461</b>	<b>6.794</b>	<b>11.606</b>	<b>21.351</b>	<b>183</b>	<b>60</b>	<b>39.994</b>

While the number of intensive care beds in Turkey was 2,214 in 2002, this number rose to 39,994 by 2020.

NUMBER OF INTENSIVE CARE BEDS PER 100 THOUSAND PEOPLE

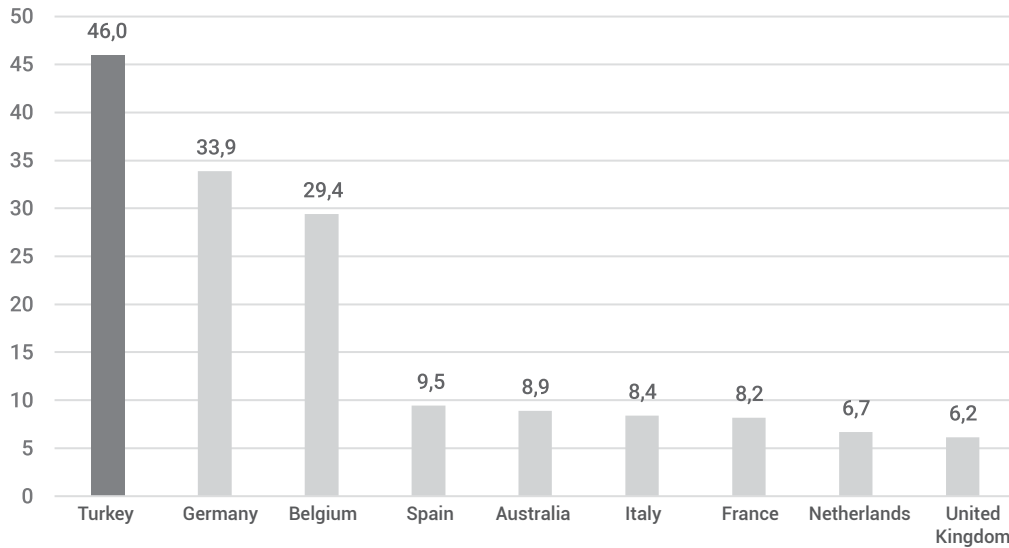

**Turkey has surpassed many developed countries like the United Kingdom, Germany, and France in terms of the number of intensive care beds per 100 thousand people. While the number of intensive care beds per 100 thousand people is 46 in Turkey, this figure is 33.9 in Germany, 9.5 in Spain, 8.4 in Italy, 8.2 in France, and 6.2 in the United Kingdom.**

## Development of Healthcare Services in Turkey: 2002-2020 Period

### NUMBER OF HEALTHCARE PROFESSIONALS IN TURKEY BY YEAR

Healthcare Professionals	2002	2014	2015	2016	2017	2018
Specialist	45,457	75,251	77,622	78,620	80,951	82,894
Practitioner	30,900	39,045	41,794	43,058	44,649	44,053
Resident	15,592	21,320	21,843	23,149	24,397	26,181
<b>Total Number of Physicians</b>	<b>91,949</b>	<b>135,616</b>	<b>141,259</b>	<b>144,827</b>	<b>149,997</b>	<b>153,128</b>
Total Number of Dentists	16,371	22,996	24,834	26,674	27,889	30,615
Pharmacists	22,289	27,199	27,530	27,864	28,512	32,032
Nurses	72,393	142,432	152,803	152,952	166,142	190,499
Midwives	41,479	52,838	53,086	52,456	53,741	56,351
Other Healthcare Professionals	50,106	138,878	145,943	144,609	155,417	177,409
Other Staff and Service Procurement	83,964	303,110	311,337	321,952	339,241	376,367
<b>TOTAL NUMBER OF PROFESSIONALS</b>	<b>378,551</b>	<b>823,069</b>	<b>856,792</b>	<b>871,334</b>	<b>920,939</b>	<b>1,016,401</b>

While the number of physicians was 91,949 in 2002, this figure increased substantially to reach 153,128 by 2018.

There has been an increase in the number of physicians per 100 thousand people in Turkey as a clear reflection of healthcare investments.

NUMBER OF PHYSICIANS PER 100 THOUSAND PEOPLE IN TURKEY BY YEAR

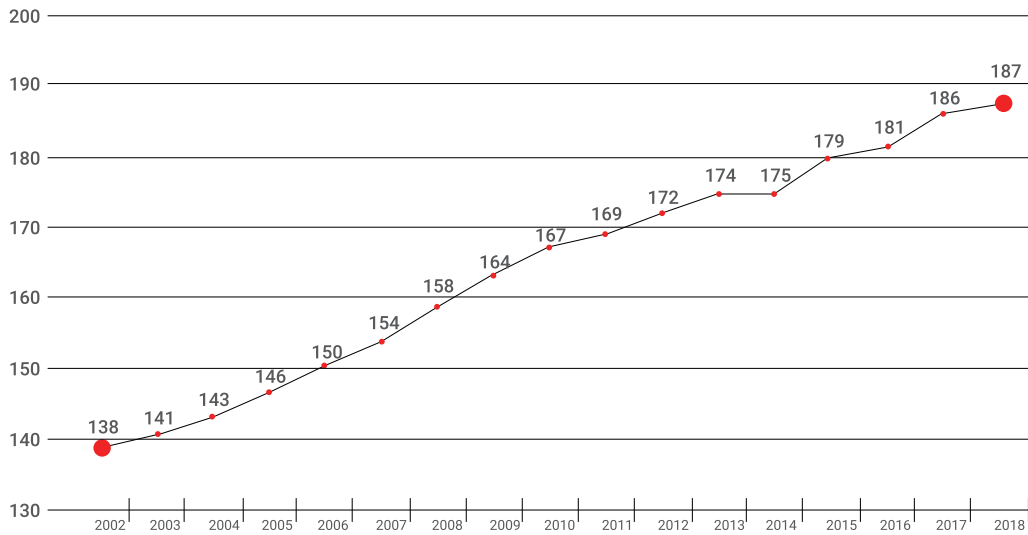

One of Turkey's important investments in the healthcare system is the city hospitals. Despite drawing criticism from certain political circles and segments of society, city hospitals have once again proven essential to our country in this global pandemic. City hospitals boost our citizens' access to healthcare services while also providing major contributions to our country's bed capacity. In the event of a global pandemic, they reinforce our capacity to resist against the pandemic in question.



**This global pandemic has once again proven fundamentally that none of the healthcare investments have been wasted and they corresponded to the needs of the society.**

# Development of Healthcare Services in Turkey: 2002-2020 Period



ANKARA BİLKENT CITY HOSPITAL



BURSA CITY HOSPITAL



KAYSERİ CITY HOSPITAL

More than half of the city hospital projects have been completed and put into service for our citizens between the years 2017 and 2019. On-going city hospital projects are expected to be completed in 2020 and 2021.

Turkey's capacity in terms of healthcare infrastructure and healthcare professionals has provided a sound basis in the country's national fight against coronavirus. **The steps taken on this basis by the state in cooperation with all of its institutions in order to minimize social interaction, encourage voluntary quarantine, and reinforce solidarity, as well as the economic and social support packages that have been introduced, have raised hopes for overcoming the pandemic with the least damage.**



## Development of Healthcare Services in Turkey: 2002-2020 Period



**9,869,019**  
INDOOR SPACE



**30,607**  
BED CAPACITY



**19,354**  
ROOMS



**7,803**  
OUTPATIENT  
CLINICS

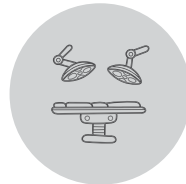

**1,085**  
OPERATING ROOMS



**5,189**  
INTENSIVE  
CARE UNITS

## Development of Healthcare Services in Turkey: 2002-2020 Period

### CITY HOSPITALS IN TURKEY

CITY	INDOOR SPACE	BED CAPACITY	TOTAL NUMBER OF ROOMS	NUMBER OF PHYSICIANS	NUMBER OF AUXILIARY HEALTHCARE STAFF	NUMBER OF OPERATING ROOMS	NUMBER OF OUTPATIENT CLINICS	NUMBER OF INTENSIVE CARE
ADANA	539,824 M <sup>2</sup>	1.550	948	597	2,055	61	330	225
MERSİN	374,601 M <sup>2</sup>	1.294	796	497	2,047	52	276	210
ISPARTA	221,571 M <sup>2</sup>	755	474	284	1,250	20	167	131
YOZGAT	141,120 M <sup>2</sup>	475	275	147	758	18	113	61
KAYSERİ	466,379 M <sup>2</sup>	1,607	994	521	2,307	43	404	273
MANİSA	178,204 M <sup>2</sup>	558	336	273	741	21	145	122
ELAZIĞ	355,752 M <sup>2</sup>	1,038	507	335	1,459	39	227	160
ANKARA BİLKENT	1,285,798 M <sup>2</sup>	3,711	2.308	1,378	5.542	131	904	674
ESKİŞEHİR	333,303 M <sup>2</sup>	1,355	636	361	1,599	38	254	152
BURSA	459,587 M <sup>2</sup>	1,105	894	361	1,605	49	403	217
İSTANBUL KARTAL (1.ETAP)	302,148 M <sup>2</sup>	789	487	491	1,544	43	192	155
İSTANBUL OKMEYDANI (1.ETAP)	180,000 M <sup>2</sup>	2,682	510	434	1,098	28	240	81
İSTANBUL BAŞAKŞEHİR-İKİTELLİ	1,019,693 M <sup>2</sup>	597	1.730	TO BE PUT INTO SERVICE	TO BE PUT INTO SERVICE	90	708	456
İSTANBUL GÖZTEPE	189,890	838	346	TO BE PUT INTO SERVICE	TO BE PUT INTO SERVICE	27	224	91
KONYA	278,776 M <sup>2</sup>	480	486	TO BE PUT INTO SERVICE	TO BE PUT INTO SERVICE	38	360	193
TEKİRDAĞ	156,890 M <sup>2</sup>	480	267	TO BE PUT INTO SERVICE	TO BE PUT INTO SERVICE	16	128	102
KÜTAHYA	180,799 M <sup>2</sup>	610	363	TO BE PUT INTO SERVICE	TO BE PUT INTO SERVICE	20	197	79
KOCAELİ	383,160 M <sup>2</sup>	1,210	786	TO BE PUT INTO SERVICE	TO BE PUT INTO SERVICE	71	258	188
ANKARA ETLİK	1,145,129 M <sup>2</sup>	3,624	2.681	TO BE PUT INTO SERVICE	TO BE PUT INTO SERVICE	125	1,031	697
GAZİANTEP	638,038 M <sup>2</sup>	1,875	1,235	TO BE PUT INTO SERVICE	TO BE PUT INTO SERVICE	62	475	277
İZMİR	629,447 M <sup>2</sup>	2,060	1,381	TO BE PUT INTO SERVICE	TO BE PUT INTO SERVICE	54	457	374
ERZURUM	409,000 M <sup>2</sup>	1,313	914	TO BE PUT INTO SERVICE	TO BE PUT INTO SERVICE	39	310	271

## Development of Healthcare Services in Turkey: 2002-2020 Period



BURSA CITY HOSPITAL



MERSİN CITY HOSPITAL





**FIGHT AGAINST COVID-19 IN  
TURKEY: EFFECTIVE MEASURES AND  
EXTENSIVE SUPPORT SCHEMES**

# Fight against Covid-19 in Turkey: Effective Measures and Extensive Support Schemes

Turkey has been pursuing a policy of multi-dimensional fight against coronavirus with the involvement of multiple actors. An effective and dedicated fight is maintained under the leadership of our President Recep Tayyip Erdoğan in order to minimize the negative impacts of coronavirus on fields such as healthcare, economy, business life, security, and social order. Various measures are being taken and economic and social support packages are being introduced in collaboration with ministries and public institutions.

The measures taken by Turkey and the support it has provided up to now can be summarized as follows in chronological order:

## **The policy of multi-dimensional and multi-actor fight against coronavirus**



# Measures Taken

The measures taken by Turkey and the support it has provided up to now can be summarized as follows in chronological order:

2020

**JANUARY 6**

● An operation centre was established within the Ministry of Health. The operation centre, where 15 people work, started to follow all developments around the world regarding coronavirus instantly.



**JANUARY 10**

● Coronavirus Scientific Board was established.



**JANUARY 14**

● 'The first version of the '2019-nCoV Disease Guideline' was prepared. This guideline consists of chapters on general information about the infection, case definition and case management, infection control and isolation, patient care and treatment, and also actions to be taken by people who will travel to the countries affected by the disease.



## MEASURES TAKEN

**JANUARY 20**

It was reported that screening upon arrival was initiated for all passengers from Wuhan in Hong Kong, India, Indonesia, Malaysia, Myanmar, the Philippines, Singapore, Taiwan, Thailand, the USA, Russia, and Vietnam.

**JANUARY 24**

Thermal camera scans were introduced for all flights from China.

**JANUARY 27**

Our citizens were advised against unnecessary travels to China, and they were advised to stay away from Hubei province and other regions with a high number of coronavirus cases when travelling to China.



# Measures Taken

## JANUARY 28

• The Scientific Board held a meeting. During the meeting, the 2019-nCoV Guidelines were updated and the frequently asked questions and answers were prepared.



## JANUARY 29

• A letter was sent to the General Directorate of State Airports Authority regarding the "measures to be taken for flights from risky areas."



## FEBRUARY 1

• Temperature scans through thermal cameras were extended.

• The plane carrying our citizens evacuated from China returned to our country. A total of 61 people including passengers, flight crew, technical staff, and healthcare professionals were placed in quarantine at Dr. Zekai Tahir Burak Hospital.



## MEASURES TAKEN

## FEBRUARY 2

• The presentation of 2019-nCoV Disease Guidelines was prepared. A briefing note was sent by the Ministry of Health to the Council of Higher Education and the Ministry of National Education for students and employees from China.



## FEBRUARY 3

• Turkey announced that it had suspended all flights from China.



## FEBRUARY 4

• Informative announcements were made during flights from the Far East (China, Thailand, Singapore, Taiwan, Malaysia, Hong Kong, and South Korea) and thermal camera scans were introduced for passengers coming from these countries.

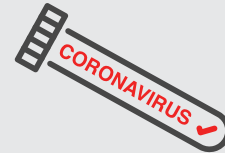

# Measures Taken

**FEBRUARY 7**

- All kinds of livestock imports from China were temporarily suspended.

**FEBRUARY 23**

- All flights from Iran to Turkey were suspended unilaterally, and the highway and railway transports were temporarily ceased.

**FEBRUARY 25**

- Planning was made to land the Turkish Airlines (THY) aircraft from Tehran in Ankara. 132 Turkish passengers and flight crew on board were transferred to Dr. Zekai Tahir Burak Hospital for their initial check-ups and quarantine.



## MEASURES TAKEN

**FEBRUARY 29**

○ All passenger round-trip flights to and from our country with China, Iran, Iraq, South Korea, and Italy were suspended.

**MARCH 2**

○ The Scientific Board held a meeting. Within the context of the new measures concerning Umrah: the public was informed that all citizens returning from Umrah had gone through a medical examination in line with the precautions and that our healthcare professionals would be present on flights from Umrah and would be assigned to accompany our citizens on the plane.

**MARCH 3**

○ The public was informed on the importance of paying attention to the '14 Day' rule upon arrivals from Umrah.

**MARCH 11**

○ Ministry of Trade announced that sanctions would be imposed on those overcharging for foodstuffs by taking advantage of the existing circumstances.

# Measures Taken

**MARCH 12**

## Coronavirus Meeting at the Presidential Complex

- Under the chairmanship of President Recep Tayyip Erdoğan, a coronavirus meeting was held at the Presidential Complex. The latest developments regarding the coronavirus pandemic as well as measures to be taken were discussed during the meeting which lasted five hours.



## MEASURES TAKEN

The meeting at the Presidential Complex was attended by,

- Vice President Fuat Oktay,
- Minister of Justice Abdulhamit Gül,
- Minister of Family, Labour and Social Services Zehra Zümrüt Selçuk,
- Minister of Environment and Urbanization Murat Kurum,
- Minister of Foreign Affairs Mevlüt Çavuşoğlu,
- Minister of Energy and Natural Resources Fatih Dönmez,
- Minister of Youth and Sports Mehmet Kasapoğlu,
- Minister of Treasury and Finance Berat Albayrak,
- Minister of Interior Süleyman Soylu,
- Minister of Culture and Tourism Mehmet Nuri Ersoy,
- Minister of National Education Ziya Selçuk,
- Minister of National Defence Hulusi Akar,
- Minister of Health Fahrettin Koca,
- Minister of Industry and Technology Mustafa Varank,
- Minister of Agriculture and Forestry Bekir Pakdemirli,
- Minister of Trade Ruhsar Pekcan,
- Minister of Transport and Infrastructure Mehmet Cahit Turhan,
- Director of Communications Fahrettin Altun,
- President of the Council of Higher Education (YÖK) Yekta Saraç,
- Presidential Spokesperson İbrahim Kalın
- President of Religious Affairs Ali Erbaş and
- Members of the Board of Health and Food Policies.

• Measures taken with regard to education were announced. Education at schools was suspended for 2 weeks as of March 16-22, 2020. The days between March 16 and 22, 2020, were declared as the mid-term break. It was stated that the Distance Learning at Home would be conducted via eba.gov.tr and TRT between March 23-29, 2020.

• The civil servants' travels abroad were subjected to special permission.

• Turkish Football Federation announced that as part of the measures against coronavirus, it was decided that all sports competitions would be held without spectators until the end of April.

• Flights to 9 European countries including Germany, France, and Spain were suspended.

# Measures Taken

## MARCH 12

- Hospital visits were restricted. It was decided not to accept visitors during working hours and to allow only one person outside the working hours.
- A circular was issued by the Presidency of the Republic of Turkey. An international travel ban was imposed on civil servants due to coronavirus. Pregnant women, women on legal breastfeeding leave, disabled employees, staff aged 60 and above except for those in executive positions working for public institutions were given 12 days of administrative leave as of March 16.
- Private kindergartens, day-care centres and children's clubs for special activities were closed.
- The leave permits of the soldiers in the headquarters were temporarily suspended.
- A circular containing coronavirus measures was sent to 81 provincial governorates by the Ministry of Environment and Urbanization. It informed that the areas where people gather in masses would be cleaned and disinfected at regular intervals as determined by the Scientific Board; disinfectants would be placed in public transportation vehicles, and places,, and buildings where public circulation was intense.
- The High Council of Religious Affairs announced that Muslims in high-risk groups in countries affected by coronavirus could perform noon prayers at home instead of Friday prayers and that Friday prayers were not fardh (religious duty) for those in quarantine areas if a decision was taken by authorities responsible for protecting public health.
- Ministry of Culture and Tourism postponed all art events until the end of April.
- A regulation was prepared and enforced for elderly people and those with chronic diseases, who purchase their medicines with medical reports, to obtain their medicine after the expiry of their reports without re-applying to hospitals.
- Events such as national and international scientific open or closed meetings, congresses,, and conferences to be held in March and April were postponed temporarily.
- Our citizens were strictly warned not to go abroad.
- It was decided not to take in those with symptoms to the penitentiary institutions.

## MEASURES TAKEN

## MARCH 13

- Prison visits were postponed for 2 weeks.
- It was decided to separate the convicts working outside for prison workshops from other convicts. The use of family visiting rooms in prisons and children's education homes was postponed for 2 weeks. Transfers from one penitentiary institution to another were postponed for 2 weeks, except in cases of security and illness.
- The postponement of trials and other judicial proceedings without urgency was left to the discretion of the judiciary.
- Due to the increased passenger volumes following the suspension of schools, vehicles with D2 and B2 certificates were also allowed to operate. Additional train services were introduced for Ankara-Istanbul and Istanbul-Ankara High-Speed Train services on March 13, 14, and 15.
- Germany, France, Spain, Norway, Denmark, Belgium, Austria, Sweden, and the Netherlands were included in the scope of the flight ban. Flights were suspended from 14.03.2020 at 08.00 a.m. until April 17. Airplanes were allowed to fly empty only to bring back our citizens.
- Flights were suspended with 11 countries that have confirmed cases.
- Ministry of Trade postponed all national and international fairs due to be held in Turkey in the period between March 16 and April 30 within the 2020 fair calendar.

# Measures Taken

## MARCH 14

- Road and air transportation were temporarily suspended with Azerbaijan. Sarp border crossing with Georgia was closed for passengers.
- Financial Stability and Development Committee (FIKKO) convened with coronavirus on its agenda and developed a road map to be introduced to support sectors that may be affected by the process and to strengthen markets.

## MARCH 15

- All passengers returning from Umrah underwent health screening; those suspected were immediately taken to the hospital and tested. They were placed in separate rooms in dormitories in Ankara and Konya for quarantine purposes.
- Ministry of Culture and Tourism announced that all libraries under the ministry would be closed to readers as of March 16, 2020, and all scheduled activities would be cancelled.

## MARCH 16

- Flights from Germany, Spain, France, Austria, Norway, Denmark, Sweden, Belgium, and the Netherlands to our country were suspended as from March 15 at 24.00 hours.
- Our citizens who have temporarily travelled for a short time to or who have been studying in the aforementioned countries and want to return to our country shall apply to the Turkish diplomatic missions in those countries until Monday, March 16 at 17:00 local time and will be able to return to Turkey until Tuesday, March 17, at 24.00. Our citizens returning to our country in this way will be held in quarantine/surveillance for 14 days within the scope of the precautions taken by the Ministry of Health and the Scientific Board.
- Minister of Justice Abdülhamit Gül announced that, as part of measures against coronavirus, judges and prosecutors over 60 years of age would be placed on administrative leave; that "notary public on duty" service was suspended until further notice and all activities and works carried out collectively by convicts under probation were halted.
- As part of the measures against coronavirus, President of Religious Affairs Erbaş stated that the situation required the suspension of prayers with the congregation, particularly the Friday prayers, in mosques and prayer rooms.

## MEASURES TAKEN

## MARCH 17

- Minister of Health Dr. Fahrettin Koca stated that the number of laboratories and diagnostic kits was increased across the country, the number of coronavirus-related laboratories would be raised to 16 and that the quick diagnostic kit would be distributed to all provinces.
- It was announced that flights to the UK, Switzerland, Saudi Arabia, Egypt, Ireland, and the United Arab Emirates would be suspended starting from March 17, at 08.00 hours, thus bringing the number of countries with which Turkey halted its flights to 20.
- Ministry of Interior sent a circular on "measures against coronavirus" to the governorates of 81 provinces.

  - According to the circular, "On the grounds that the risk of transmission of the disease would increase, in case our citizens come together collectively at a very close distance to places that are operated as Recreational and Entertainment Public Places; the activities of theatres, cinemas, performance centres, concert halls, engagement/wedding-ceremony halls, restaurants/cafés with live performance/music, casinos, pubs, taverns, coffee houses, coffee shops, cafeterias, countryside gardens, water pipe lounges, water pipe cafés, internet cafés, all kinds of video game arcades, all kinds of indoor playgrounds for children, tea gardens, clubhouses, amusement parks, swimming pools, Turkish baths, saunas, thermal springs, massage parlours, SPAs, and sports centres" have been temporarily suspended as of today at 00.00 hours.
- The plenary sessions of non-governmental organizations (associations, foundations) and all kinds of meetings and activities of non-governmental organizations, including trainings that bring people together, except for administrative activities which are required to be carried out, have been temporarily suspended as of 00:00.
- The activities of condolence houses, where citizens come together collectively, have been suspended as of 00:00.
- The Minister of Family, Labour and Social Services stated that the duration of the 10-day report that could be issued by a single physician at a time has been extended to 14 days.
- The Ministry of National Defence announced that the visitors would not be allowed to its units, headquarters, and institutions.
- The Ministry of National Defence stated that nobody would be allowed to the officer's clubs and guesthouses, except the employees in charge and those who stay there due to compelling reasons.
- The national and international manoeuvres were postponed by the Ministry of National Defence.
- The Military Academies and Non-Commissioned Officer Vocational High Schools and Military Institutes affiliated with the National Defence University were temporarily closed until April 13.

# Measures Taken

**MARCH 18**

## **Coordination Meeting on the Fight against Coronavirus**

- The Coordination Meeting on the Fight against Coronavirus was held under the chairmanship of President Recep Tayyip Erdoğan at Çankaya Presidential Palace. The meeting was attended by Vice President Fuat Oktay, members of the Presidential Councils of Economy and Health Policies, Ministers, administrators from public institutions and organizations, managers from AK Party, and representatives of non-governmental organizations.
- President Erdoğan announced the package called "Economic Stability Shield" totalling 100 billion TL in his address to the nation following the meeting that lasted 3 hours and 50 minutes.
- Recalling that they are the members of a civilization that says "Humans come first" and also the members of a culture that argue, "Keep the people alive so that the state could live," President Erdoğan stressed that the measures taken in this process aimed to protect people's lives and future.



## MEASURES TAKEN

## MARCH 19

- Football, basketball, volleyball, and handball leagues were delayed indefinitely.
- In accordance with a decision taken by the Ministry of Culture and Tourism, the events started to be broadcast for the audience on TRT 2 channel with the slogan "The Excitement of Art is in our Houses" as of March 24, 2020.sunulmaya başlandı.

## MARCH 20

- The foundation hospitals and private health institutions that fulfil the conditions were declared pandemic hospitals.
- PTT started to deliver their cargoes to its customers through the "Contactless Delivery" method thanks to its hand terminals.
- The Ministry of National Defence designated manners to be applied at border units in the course of contacting the persons caught in illegal border crosses in order to be protected from coronavirus. The personnel was equipped with protective gowns, gloves, and masks.

## MARCH 21

- In addition to 22 countries, flights to and from 46 more countries were suspended by Turkey, and thus the number of such countries increased to 68.
- Ministry of Interior suspended the operations carried out by barbers, hairdressers and beauty salons as of 18.00 hours until further notice.
- Ministry of Agriculture and Forestry stated that having barbecues in national parks, forests, promenade areas and parks and gardens affiliated to the ministry has been forbidden.

# Measures Taken

## MARCH 22

- Ministry of Interior introduced that citizens over 65 years of age and those with chronic illnesses were restricted from leaving their homes.
- Ministry of Interior decided that all diners and restaurants, whether serving alcohol or not, and similar businesses such as patisseries would only provide delivery and takeaway services.
- In accordance with a circular published in the Official Gazette by President Recep Tayyip Erdoğan, the civil servants were allowed to work in flexible schemes such as remote work and work in rotation.

## MARCH 23

- In courthouses, remote work was initiated with the exceptions of actions regarding convicts and other urgent matters. It was decided that notary offices would work in rotation.
- The Council of State elections were postponed.
- Work was initiated concerning imposing sanctions on the companies attempting at stocking medical supplies such as masks and gloves and marketing them with excessive prices.

## MARCH 24

- It was decided that the supermarkets would serve between 09:00 and 21:00 and that the number of customers to be allowed simultaneously to supermarkets would be limited.
- It was decided that the inner-city and inter-city public transport vehicles would be able to allow passengers only up to 50 percent of its capacity.
- The Centre for Fight against Coronavirus was established within the Ministry of National Defence for managing and monitoring the precautionary measures regarding the pandemic at units and headquarters.

## MEASURES TAKEN

MARCH 25

**Scientific Board Meeting on Coronavirus**

- President Recep Tayyip Erdoğan made a statement during the Scientific Board Meeting on Coronavirus, which he attended through videoconferencing on March 25, 2020.
- Stating that the work and recommendations by the Science Board have played a great role in the measures taken by Turkey against this disease and the relatively mild course of the process, President Erdoğan said, "Thank God, our nation has greatly appreciated the measures we have been taking as part of our fight against this virus and complied to them to a great extent. Even if some people in our society are yet to comprehend the magnitude of the threat, we are generally satisfied with our nation's sensitivity. I believe that those who still do not comprehend the vitality of the issue will see the reality as soon as possible with your suggestions and recommendations."



## Measures Taken

**MARCH 25**

- President Erdoğan was briefed by Minister of Health Fahrettin Koca and Minister of National Education Ziya Selçuk during the meeting, which was also attended by Minister of Treasury and Finance Berat Albayrak, Director of Communications Fahrettin Altun and Presidential Spokesperson İbrahim Kalın.



## MEASURES TAKEN

- It was decided that schools would be shut down until April 30 and distance learning would continue.
- It was decided that the bread and bread varieties would be sold not in open areas such as bazaars and greengroceries, streets, and portable counters, but in paper and plastic packages.
- All execution and bankruptcy procedures were called off from March 22, 2020, to April 30, 2020.
- All periods regarding the origination, exercise, or termination of a right, including filing a lawsuit, initiating enforcement proceedings, application, complaint, appeal, notice, notification, submission and timeout periods, deprivation times, and mandatory administrative application periods were stopped until April 30, 2020.
- The closed and open biddings to be conducted for immovable properties of the treasury throughout Turkey were cancelled by the Ministry of Environment and Urbanization, and it was decided not to make any tenders until the end of April.

# Measures Taken

## MARCH 26

- It was decided that universities would not provide face-to-face education in the spring semester this year and that the courses would continue through distance learning, open learning, and digital education.
- It was announced that the Higher Education Exam (YKS) would be held on July 25-26.
- The meetings of municipal councils of metropolitans, provinces, districts, and towns, as well as local administrative units and provincial councils to be held in April, May, and June were postponed to prevent people from coming together collectively.
- The export of ventilators was bound to permission by the Turkish Pharmaceuticals and Medical Devices Agency.
- The production of surgical masks and N95-type masks was accelerated by the sewing houses of the Ministry of National Defence and the Machinery and Chemical Industry Corporation (MKE) Directorate of Maksam Machinery and Mask Factory.

## MARCH 27

- The exam calendar of the ÖSYM for 2020 was updated. It was decided that the Public Personnel Selection Exam (KPSS) Field Knowledge Test would be held on September 12-13; General Knowledge-General Culture-Educational Sciences sessions on September 6 and the KPSS Teacher Field Knowledge Test on September 20.
- The second and third instalment payments of pilgrimage candidates and preparations and procedures regarding the Hajj pilgrimage were postponed until further notice.
- The sale of items such as clothing, toys, and similar ornaments in bazaars was forbidden. Furthermore, it was announced that a distance of a minimum of three meters would be kept between market booths.
- The citizens' activities such as picnicking, fishing, exercising, and walking, etc. were banned at the seashores, recreation areas, archaeological sites, and picnic areas during weekends in districts and provinces until the fight against coronavirus ends. The extension of such measures into the weekdays was allowed, depending on the situation of provinces and districts.

## MEASURES TAKEN

## MARCH 28

- The Provincial Pandemic Board Meeting was held simultaneously at all governorates.
- Inter-city bus services were subjected to the permission from the governorates from 17.00 as of 28.03.2020 in order to prevent the spread of the virus. Within this context, it was made possible to make inter-city journeys for citizens who were referred only by the physician's decision due to their treatment needs, those whose immediate relatives died or those with severe illnesses, and especially those who have arrived without any place to stay in the last fifteen days.
- At the entry and exit points of 81 provinces, fever and health status checks were introduced for citizens travelling in their private vehicles.
- A "Travel Permit Certificate" requirement was introduced to passengers for domestic air transportation.
- Turkish Airlines announced that it would conduct domestic flights to only 14 metropolitan cities.
- 12 towns and villages were placed in quarantine, while 211 thousand 670 workplaces were shut down.
- It was determined that healthcare workers working in all public and private sector healthcare institutions would not be allowed to leave their posts for three months.
- All prison visits, transfers between prisons and the use of family meeting rooms were postponed for another two weeks.
- "Vefa Social Support" groups, which were formed after imposing restrictions on those over the age of 65 and those with chronic illnesses to leave their residences, came to the aid of those complying with the call to "stay at home" throughout the country.
- The vehicle inspections were postponed for those over the age of 65 and on curfew.

# Measures Taken

## MARCH 29

- 160 individuals were detained in 30 province during the operations against those charging high prices for products and threatening the health of citizens.
- Inter-city bus services started running with permission from the governorates from 17.00 as of March 29.
- General Command of Gendarmerie started manufacturing 100 thousand cloth masks per day.
- 131 Turks brought to Turkey by air from Ethiopia were placed in a student dormitory in İzmir.
- It was decided that convicts and detainees would be able to have 30-minute-long video calls a week with their relatives in the institutions determined by the Ministry of Justice.
- It was decided that 3 thousand 135 people who were placed in dormitories in Ankara upon their return from Umrah and completed their quarantine period would be sent to the provinces they live by 112 buses and six planes.
- The Governorate of Ankara prohibited the entry of children into bazaars and supermarkets as well as passenger transport via web-based applications.
- Due to a positive case diagnosed in Yeşildere village of Kütahya, the area was placed in quarantine.

## MARCH 30

- In accordance with a circular brought into force by the Ministry of Interior, the commercial taxis operating in the traffic in Istanbul, Ankara, and İzmir were restricted. According to the circular, it was decided that the taxis with an odd license number would operate in the traffic until 24.00 and those with an even number after that time.
- Ministry of Interior stated that 39 settlements, including one town, six neighbourhoods, 28 villages, and four hamlets in 18 provinces have been placed in quarantine.
- As part of the measures against coronavirus, applications for "Travel Permit Certificates" started on the e-Government platform.
- It was stated that personnel working in prisons would not be allowed to go to their houses and would stay in isolated locations.
- The sea bus, ferry, etc. services carrying passengers in Istanbul was stopped.

## MEASURES TAKEN

## MARCH 31

- The Constitutional Court (AYM) announced that the periods related to individual applications were suspended from March 13 to April 30 as part of the fight against coronavirus.
- Ankara Provincial Directorate of Health decided that pharmacies would be open on weekdays and Saturdays from 10.00 to 18.00.
- The ban on the entry of visitors to the Grand National Assembly of Turkey was extended until April 30 within the context of the measures against coronavirus.
- The number of additional personnel to be appointed openly or through the transfer method in the public sector in 2020 was designated in the context of the fight against coronavirus. 62 public institutions and organizations were authorized to appoint 6,219 persons.
- A free disinfection station was set up to disinfect taxis and service vehicles in Ankara.
- As part of measures against the novel coronavirus, the citizens who were placed in quarantine upon arrivals from umrah started to be discharged.
- Images of the demo prototype of the first locally manufactured ventilator in service, which was developed in the context of the fight against coronavirus, were shared with the public.
- In addition to current measures, the Ministry of National Defence took additional measures for units at zones of operations in northern Syria regarding the entries to and exits from zones of operation.

## APRIL 1

- Ministry of Interior sent a new letter to governorates regarding the measures to be taken at bazaars. Accordingly, it was decided that areas other than the entrances and exits of bazaars would be closed with iron barriers and that entries and exits into the area would be made from separate points. Furthermore, it was decided that a distance of a minimum of three meters would be kept between market booths and that the number of citizens doubling the number of artisans would not be allowed to the area.
- Speaking in a press conference organized after the Scientific Board Meeting on Coronavirus, Health Minister Koca stated that the number of Covid-19 tests performed per day has reached 15,000 and that it would exceed 20,000 in a week.
- YÖK announced that thesis defences and proficiency exams at universities could be held through video conference or similar digital methods, on the condition that they can be inspected and recorded.

# Measures Taken

## APRIL 2

- The suspension on the scheduled international and domestic flights of Turkish Airlines until April 17 was extended to May 1 in accordance with a new decision.
- Minister of Industry and Technology Mustafa Varank made an important statement during a virtual conference on the studies to develop a vaccine against coronavirus. Minister Varank said that there were 14 vaccine-medication development projects and that hundreds of researchers from 40 institutions were working on the matter.
- Istanbul Governor Ali Yerlikaya said that the pharmacies in the city would furnish services from 09.00 to 18.00 except for Sundays as part of the measures against coronavirus.
- It was decided to close the PTT branches, which became quite busy due to social aid payments, and to make the payments through PTT distributors to the people concerned, along with law enforcement officers and guards, at their homes.

## APRIL 3

- As part of his statement following the Scientific Board Meeting on Coronavirus, President Recep Tayyip Erdoğan made the following remarks,
  - A ban was imposed on vehicle entrances and exits for 15 days in 30 metropolitan cities and the city of Zonguldak,
  - A curfew was imposed on people under the age of 20,
  - Wearing masks was made compulsory in crowded places such as bazaars and supermarkets,
  - The social distancing rule of at least three steps must be observed in all public places, including streets.
  - Turkish Red Crescent (Kızılay) made a call for the donation of the “immune plasma” method.
  - Motor vehicle owners unable to go through due vehicle inspection within three months were given a 45-day time for the procedure as from the end of such period.
  - “Comparative Billing” was introduced for electricity and natural gas. It will be applied in settlements, which are under quarantine and meter readings have been suspended in accordance with an administrative decision and in cases where the officials reading the meters are unable to maintain their social distance, and it will be applied for three months based on averages of the same months of the last two years.
  - It was announced that unemployment benefits would be delivered to the recipients' homes on April 5, 6, and 7.

## MEASURES TAKEN



- The prospective "Covid-19 Case Inquiry Guide" of the Ministry of Health was updated. Accordingly, all patients with at least one of the symptoms of fever, cough, and shortness of breath will be guided towards the area reserved for Covid-19 by wearing a mask.
- 1,929 people coming to Kırıkkale province from other provinces were put under home quarantine in Kırıkkale. Furthermore, 83 Turkish citizens who have been brought to Turkey from Qatar were quarantined in Yalova, 150 people brought from Azerbaijan were quarantined in Muğla and 343 people brought from Kuwait were put under quarantine in Trabzon and Giresun.
- A neighbourhood in Malatya and a village in Karaman were placed in quarantine due to coronavirus.
- A pharmaceutical company in Turkey produced the first batch of drugs, which are among its products and which were observed in researches to yield positive results against coronavirus and delivered it to the Ministry of Health.
- The Scientific Board on Coronavirus convened for the first time through videoconferencing. O The discharge efforts initiated for nearly 1,200 Turkish citizens in Algeria so as to ensure that they are brought to the country by the airplanes of the Turkish Airlines and the Algerian Airlines.

# Measures Taken

## APRIL 4

- It was reported that the domestic flights of Turkish Airlines were suspended until April 20.
- 334 Turkish workers, who were brought to Turkey from Iraq, were placed in student dormitories of the General Directorate of Higher Education Credit and Hostels Institution (KYK) in Kütahya.
- The Governorate of Istanbul declared that the discharge certificates would be sufficient for those who would be discharged from the paid military service and who would like to leave Istanbul.
- It was announced that the unemployment insurance, job loss indemnity payments, guarantee fund payment, and short-term work payments would be made to citizens by PTT employees in their residences as of April 6.
- Inspections were initiated within the scope of the ban on the vehicle entrances and exits applied in 30 metropolitans and Zonguldak.
- The curfew imposed on people under the age of 20 as part of the fight against the pandemic in Turkey started to be implemented.
- It was announced that a total of 1 million masks and 5 thousand overalls had been produced per week by the Directorate of Sewing Houses, and 5 thousand litres of alcohol-based disinfectants had been produced per week by the Directorate of Pharmaceutical Factories.
- Gebze Technical University announced that efforts were initiated to produce two different "rapid diagnostic kits" as part of the fight against Covid-19.

## APRIL 5

- According to an additional circular by the Ministry of Interior, people aged 18-20 working in public institutions and organizations, people who prove with a social security document that they are working regularly in the private sector and also the seasonal agricultural workers were exempted from the curfew.
- 299 Turkish citizens brought from Algeria were placed in quarantine in a student dormitory in Manisa.
- According to a decision taken by Kastamonu Provincial Sanitation Council, a ban was imposed on entrances from other villages of the centre of Kastamonu to the provincial centre and districts by automobiles and minibuses.

## MEASURES TAKEN

## APRIL 6

- It was announced that the “immune plasma” therapy has been put into use in the fight against Covid-19.
- As part of the measures against coronavirus, the process of discussing the new protocol regarding the supply of medications was postponed. The current protocol was extended to ensure that the citizens can benefit from health services without interruption and the supply of medications is not disrupted.
- In accordance with a letter sent by the Ministry of Health to governorates, wearing masks was made compulsory in entrances into health institutions.
- It was announced that investigations have been launched against persons who share manipulative posts regarding coronavirus, act in an offending manner against citizens, violate the quarantine measures, stockpile, and sell smuggled medical supplies.
- Brochures were distributed at road checkpoints in the Peace Spring region and the measures to be taken to be protected from the virus have been announced in residential districts.
- Ministry of National Education prepared a show named “BİZDEN” (FROM US) for parents to be broadcast on the TRT EBA channel in order to provide parents with practical information as part of the measures against Covid-19.
- YÖK decided to postpone the Placement Tests (STS) and equivalent exams to be held by universities in April, May, and June.

## APRIL 7

- The distribution of cologne and masks for citizens over the age of 65 announced by President Erdoğan started to be implemented by guards.
- The construction work on the hospital in Sancaktepe, one of the two pandemic hospitals to be built in Istanbul, was initiated.
- The first donation of immune plasma to be taken from the recovered patients was carried out at Kızılay in order to be used for the Covid-19 treatment.
- Members of the GNAT started to join the sessions by wearing a mask and members of the Parliament were offered cologne.
- The preparations for a system aimed at digitally monitoring the patients who are isolated at home were initiated by the Ministry of Health.

# Measures Taken

## APRIL 8

○ The packages of cologne and masks distributed to citizens over the age of 65 included a message by President Recep Tayyip Erdoğan regarding the coronavirus pandemic. The message noted the following;

- Turkey is the country best prepared to handle the pandemic,
- Every means available are used against the pandemic,
- We have a strong army of a total of 850 thousand healthcare professionals,
- Everybody must strictly stay home and not go outside until the threat of pandemic disappears,

■ Calling phone numbers 112, 155, and 156 will prompt the Vefa Social Support Groups to meet all needs.

○ President Recep Tayyip Erdoğan held a phone conversation with the Chinese Head of State Xi Jinping, and the two leaders discussed the issues of cooperation against coronavirus.

○ As part of the measures against coronavirus, the bill prescribing amendments to the Higher Education Law was presented to the GNAT.

○ A videoconference titled “Covid-19 Experiences and International Cooperation in Fight against Pandemic” was held by the Directorate of Communications.

○ Directorate of Communications announced the Pandemic Isolation Tracking Project (ITP), which has been developed by the Ministry of Health to contain the Covid-19 pandemic and to isolate the patients.

○ A statement made by the Ministry of Interior said that the quarantine process has been carried out in 156 settlements as part of the measures against coronavirus and that the same process has been ended in six settlements in a total of five provinces.

○ A legislative proposal was presented to the GNAT in order to prevent violence against healthcare professionals.

○ It was announced that the masks, overalls, and diagnosis kits, prepared by the Ministry of Health, would be delivered to Serbia, Bosnia and Herzegovina, Montenegro, Northern Macedonia, and Kosovo by an aircraft of the TAF.

○ A circular was prepared by the Ministry of Environment and Urbanization regarding the waste management of hygiene materials such as disposable masks and gloves. The circular indicated the following;

## MEASURES TAKEN

## APRIL 9

- Mask and gloves waste shall be collected at entries and entrances of institutions and businesses and in common use areas,
- Mask and gloves waste in houses and workplaces shall be kept for a minimum of 72 hours and then delivered to municipalities as domestic waste,
- The waste at the quarantine divisions of health institutions shall be managed as “medical waste” and their separation from other waste shall be ensured.
- President of Religious Affairs Ali Erbaş announced that tarawih prayers would be performed in houses during the month of Ramadan, in case the coronavirus pandemic persists.
- Pandemic Isolation Tracking Project was launched in cooperation with the Ministry of Health, Information Technologies and Communication Authority, and all GSM operators.
- Higher Council of Religious Affairs announced that the bodies of those who have died of Covid-19 should be washed, enshrouded, and buried in due form, after taking protective measures.
- 288 operations have been carried out in 65 provinces by the Ministry of Interior against profiteers who attempt at producing disinfectants, cologne, masks, and medical products without authorization, and 462 people have been detained. 6 million masks have been seized.
- The circular issued by the Ministry of Interior announced that the children and adolescents under 20 years of age with “special needs” would be allowed to leave their residences, provided that they fulfil the appropriate conditions.
- The “Circular on Measures for Wastewater Management” was published by the Ministry of Environment and Urbanization within the scope of the fight against coronavirus. Accordingly, the refined wastewater used for watering will be disinfected. Water sports and grain washing will not be allowed at the watercourse discharge areas.
- Ministry of Health prepared a brochure regarding the measures to be taken against coronavirus at indoor workplaces and offices.

# Measures Taken

## APRIL 10

- President Recep Tayyip Erdoğan attended a video conference summit on the "Cooperation and Solidarity in Combating the Covid-19 Pandemic," held by the Cooperation Council of Turkic Speaking Countries.
- President Recep Tayyip Erdoğan and Bulgarian President Rumen Radev held a phone conversation. During the conversation, cooperation in the fight against coronavirus was discussed.
- It was announced that the restoration work on the Historic Hadımköy Military Hospital would be completed in 45 days, and the hospital would be brought into service.
- It was announced that the National Defence University Exam has been postponed to June 14 by the ÖSYM, and the procedures regarding military student candidate preferences have been postponed as well.
- A temporary ban was imposed on private vehicle entries into and exits from Ayvalık, Gömeç, Burhaniye, and Edremit districts of Balıkesir.
- The meetings of consumer arbitration committees were postponed to April 30 in order to prevent losses of rights.
- Officials from the Ministry of Health and members of the Scientific Board on Coronavirus held a meeting with Chinese experts via videoconference.
- A curfew was declared in 30 metropolitan cities and Zonguldak for two days as of midnight on April 10, 2020 (April 11-12).

## APRIL 11

- Minister of Youth and Sports Mehmet Kasapoğlu announced that, 13 thousand 968 citizens have been in quarantine in dormitories, and that 17 thousand 504 citizens have left dormitories.
- Ministry of Justice announced that the interviews with prospective judges and prosecutors scheduled to be held on May 4-July 10 have been postponed within the scope of the measures against coronavirus.

## APRIL 12

- The use of masks was made mandatory in public vehicles operating in Ankara and inter-city and inter-district vehicles carrying passengers, taxis, all sorts of commercial vehicles, service vehicles, and private vehicles with more than one passenger.
- Yozgat City Hospital was turned into a pandemic hospital in order to fight Covid-19.

## MEASURES TAKEN

## APRIL 13

- President Recep Tayyip Erdoğan said that a curfew would be maintained on weekends, depending on requirements. It was decided that a curfew would be imposed on Friday night April 17, from 24.00 to Sunday, April 19, 24.00.
- It was announced that a confirmation code has been delivered to 32 million people by the Ministry of Health as part of the practice of free masks for every citizen.
- Turkish Pharmacies' Association announced that the distribution of masks that were initiated in pharmacies in Ankara and Istanbul on April 10 would be rapidly extended to other provinces as well.

## APRIL 14

- Ministry of Justice announced that discharges would be initiated as soon as the Law on Criminal Execution, adopted by the GNAT, is enacted and that they would be completed until Friday.
- Ministry of National Defence announced that a proposal would be submitted for the President's approval so as to ensure that the call-up periods and discharges are postponed for one month, as it is estimated that calling-up and discharging the Turkish soldiers would pose a risk against society and the TAF due to the coronavirus threat.
- Ministry of Agriculture and Forestry prepared a poster and brochure that contains information about Covid-19 to be sent to 81 provincial and district directorates, farmers, producers, retail sector, and associations.
- Ministry of Health prepared five new public service ads consisting of issues regarding compliance with such rules as social distancing and wearing a mask in order to fight coronavirus.
- It was reported that a 78-year-old patient who has been treated with convalescence plasma at Akdeniz University Hospital tested negative for Covid-19.
- Erciyes University, Directorate General of Vaccine Research and Development Centre announced that the total gene map of coronavirus has been prepared.
- Turkish Airlines announced that it has suspended all its international flights until May 20.

# Measures Taken

## APRIL 15

- The bill consisting of economic measures against the coronavirus pandemic has been adopted by the Plan and Budget Committee of the GNAT.
- As part of the fight against Covid-19, infection control measures at centres providing healthcare services for cancer patients was updated by the Ministry of Health.
- Ministry of Interior announced that judicial/administrative actions were taken against 1,183 business owners and customers during inspections by police and gendarmerie teams.
- Ministry of Interior reported that quarantine measures were implemented in 227 locations in 58 provinces, and the quarantine period in 41 locations in 14 provinces was terminated.
- Foreign Minister Mevlüt Çavuşoğlu announced that 25 thousand citizens who were abroad during the coronavirus period were brought to Turkey and that the Turkish citizens who are still abroad and who have applied for returning to Turkey would be brought back as soon as possible, after preparing the quarantine conditions.

## APRIL 16

- President Recep Tayyip Erdoğan held a phone conversation with Georgian President Salome Zourabichvili and discussed issues of cooperation in the fight against Covid-19.
- Ministry of Interior sent a circular to the governorates of 81 provinces on the curfew to be implemented in 30 metropolitan cities and Zonguldak during the weekend. The circular indicated that the bakeries producing bread, public and private health institutions and organizations and pharmacies would be open during the weekend.
- During the inspections on 772 bazaars in districts and neighbourhoods in 81 provinces by 3 thousand 95 police and gendarmerie personnel, administrative actions were taken against 342 artisans and customers violating the rules.
- Rize Governorate announced that the producers would be able to enter the city with a travel permit certificate for the tea agriculture until April 30.

## MEASURES TAKEN

## APRIL 17

- The Presidential decree on the postponement of discharges for one month was published in the Official Gazette.
- Vice President Fuat Oktay announced that 25 thousand Turkish citizens from 59 countries would be brought to Turkey as part of the fight against the coronavirus pandemic.
- Ministry of Interior announced that there would be inspections on the social distance rule and the requirement to wear a mask at the places involving dense shopping, fuel stations, and bus stops.
- Minister of Trade Ruhsar Pekcan announced that the Unfair Price Assessment Board would continue the fight against exorbitant price increases. It was announced that the Board would investigate exorbitant prices and stockpiling and would be entitled to impose administrative fines of up to 500,000 TL.
- Ministry of Interior reported that 5,603 social media accounts, which had unsubstantiated and provocative coronavirus messages have been investigated on social media in the last 31 days, 765 suspects have been identified and 303 have been detained.
- 349 Turkish citizens in the Netherlands were brought to Turkey as part of the measures against Covid-19.
- It was announced that Turkish Airlines would arrange a special flight on Wednesday, April 22 for citizens unable to return to Turkey from Pakistan after the flights had been cancelled as part of the Covid-19 measures.
- The aircraft carrying 349 Turkish workers employed in Kuwait arrived at Antalya Airport as part of the evacuation operation launched from 59 countries.
- 62 Turkish citizens brought to Turkey from Libya as part of the measures against Covid-19 were quarantined in a dormitory in Çorlu for 14 days.
- 262 Turkish citizens brought from London as part of the measures against Covid-19 were placed in the Credit and Hostels Institution dormitory in Çankırı.
- 142 Turkish citizens, including one infant, brought to Turkey from Ukraine as part of the measures against Covid-19 were placed in the Credit and Hostels Institution dormitory in Rize.
- 32 people brought from Iraq to Kayseri as part of the measures against Covid-19 were placed in the student dormitory of the Credit and Hostels Institution.

# Measures Taken

## APRIL 18

- Aziz Sancar Research Centre was transformed into the "Covid-19 Diagnosis Centre" as part of the fight against the coronavirus pandemic.
- Ministry of Family, Labour, and Social Service launched a Social Isolation Organization in 81 provinces of Turkey.
- Warning signs related to Covid-19 were hung on boards and in corridors at the headquarters of the Ministry of National Defence.
- Erzincan Binali Yıldırım University, Mengücek Gazi Education and Research Hospital began accepting patients via the 'online outpatient clinic' service.
- It was announced that this year, as part of the fight against coronavirus, the Historical Kırkpınar Oil Wrestling, and Kakava Festivals would be held symbolically.

## APRIL 19

- Ministry of Health issued a briefing note regarding the immune plasma therapy. Women who have not conceived and men between the ages of 18-60, people who have not had blood transfusions at any point in their lives, individuals who have Covid-19 diagnostic laboratory test results and those who have received two negative test results following full clinical recovery, were said to be able to donate plasma to patients with coronavirus.
- Ministry of National Defence announced plans to increase weekly mask production to 10 million, overalls production to 110 thousand and disinfectant production to 40 thousand litres.
- Ministry of National Education announced that in addition to vocational high schools, public education centres and maturation institutes have also focused on the production of medical equipment and that the monthly production capacity for masks in Istanbul has reached 5 million, while it has reached 10 million in Turkey.

## MEASURES TAKEN

## APRIL 20

- The first phase of Başakşehir City Hospital, which has a closed construction area of 1 million square meters and a capacity of 2,682 beds, was opened. President Recep Tayyip Erdoğan attended the opening ceremony via video conference method. It was announced that the hospital would be fully operational on May 15.
- Industry and Technology Minister Mustafa Varank announced the delivery of the first batch of local and national ventilators to the Başakşehir City Hospital.
- Minister of Health Fahrettin Koca stated that daily testing capacities were increased and that the measures taken against coronavirus were bearing their fruits.

- Siirt Governorate announced that the quarantine had been lifted at nine points in Siirt.
- President Recep Tayyip Erdoğan chaired the cabinet meeting held via video conference. In his statement after the cabinet meeting, President Erdoğan announced the following;
  - 5,000 local ventilators will be produced by the end of May,
  - A curfew will be implemented from April 22, 24.00 to April 26, 24.00,
  - In 43 university hospitals, which include medical faculties in their bodies, 8,534 temporary staff and 5,000 worker positions in various titles were established.

## APRIL 21

- Ministry of Interior sent circulars to the governorates of 81 provinces regarding the measures to be taken in Ramadan and curfews to be imposed on April 23, 24, 25, and 26.
- Ministry of Agriculture and Forestry began the analysis of wastewater for coronavirus.
- The Executive Order issued by the President announcing certain regions of Istanbul and Bitlis as “risky areas” was published in the Official Gazette.
- The Presidency announced that all employees in public institutions and organizations would be considered on administrative leave on Friday, April 24.
- A circular regarding the measures to be taken in Ramadan was sent to the governorates of 81 provinces by the Ministry of Interior. Accordingly;
  - Fast-breaking tents will not be allowed and visits to tombs will be restricted.
  - Ramadan drummers will not be allowed to collect tips from the citizens; the cost of their services will be paid by the local administrations.
  - The sale of Ramadan pita will be terminated two hours before the fast-breaking time.
  - The number of public transport vehicles and

# Measures Taken

## APRIL 21

their trips will be increased at least three hours before fast-breaking time.

- Visits to cemeteries will be restricted. Fever checks will be conducted during cemetery visits on the eve of and during Eid al-Fitr.
- More audits will be performed on companies that sell products with excessive prices by taking advantage of Ramadan and Eid al-Fitr, and the necessary administrative procedures will be carried out immediately.
- 245 Turkish citizens brought from Belgium were quarantined in Gümüşhane.
- 298 Turkish citizens brought from Ukraine were quarantined in a dormitory in Manisa.
- 426 people who were brought to Turkey from Bangladesh, Czechia, Kosovo, and Bahrain as part of the measures against coronavirus were placed in dormitories in Karaman, Karabük, Uşak, and Gaziantep.

## APRIL 22

- President Recep Tayyip Erdoğan held a meeting with players of the National Football Team via video-conference. Minister of Youth and Sports Mehmet Muharrem Kasapoğlu, President of the Turkish Football Federation Nihat Özdemir, Coach of the National Football Team Şenol Güneş and the footballers were present during the video-conference.
- 133 Turkish citizens brought from Pakistan to Turkey as part of the Covid-19 measures were placed in a dormitory in Eskişehir.
- 270 Turkish citizens were brought from Northern Macedonia to Turkey. Citizens brought from abroad were placed under surveillance in dormitories in Artvin for 14 days.
- The Turkish Airlines plane, carrying 179 Turkish citizens from Russia arrived at Adana Airport.

- 29 Turkish citizens brought from Afghanistan were placed in a dormitory in Yozgat.
- 348 Turkish citizens in Kuwait were flown to Ankara on a Turkish Airlines plane.
- 180 Turkish citizens brought from Sudan were placed in dormitories in Kütahya.
- 349 Turkish citizens from the Netherlands were brought to Turkey. Citizens brought from abroad were placed under surveillance in dormitories in Denizli for 14 days.
- 75 Turkish citizens brought from Montenegro were placed in a dormitory in Tekirdağ.
- 350 Turkish citizens in Saudi Arabia were brought to Izmir by a Turkish Airlines plane.
- After he passed away due to Covid-19, the family health centre where Dr. Yavuz Kalaycı worked was named after him.

## MEASURES TAKEN

## APRIL 23

- As part of the fight against coronavirus, the curfew to be implemented in Zonguldak and 30 metropolitan cities on April 23, 24, 25, and 26 began.
- 249 Turkish citizens brought from Oman to Turkey as part of the Covid-19 measures were placed in student dormitories in Van.
- Following the closing of the borders to prevent the spread of the Covid-19 pandemic, Turkish citizens who were in Baku, the capital of Azerbaijan, were brought to Turkey with a Turkish Airlines plane.
- 817 Turkish citizens in Germany and 50 of their relatives of German nationality were brought to Ankara, Adana, and Trabzon.
- 344 Turkish citizens brought from Algeria as part of coronavirus measures arrived at Gaziantep.
- 94 Turkish citizens brought from Serbia were placed in dormitories in Kütahya.

## APRIL 24

- 181 Turkish citizens in Azerbaijan were brought to Ordu.
- 182 Turkish citizens brought from Sudan to Turkey as part of the measures against Covid-19 were placed in a dormitory in Siirt.
- 349 Turkish citizens evacuated from Canada were brought to Istanbul as part of the measures against novel coronavirus. Passengers were transported to Kırklareli to be placed in dormitories.
- 188 Turkish citizens brought from Russia to Turkey were placed in a student dormitory in Kastamonu.
- 150 Turkish citizens brought from Spain to Turkey as part of the measures against novel coronavirus were placed in a student dormitory in Amasya.
- 166 Turkish citizens in Jordan were brought to Samsun by a Turkish Airlines plane.
- The Ministry of Health launched a communication channel through which all information about coronavirus could be obtained via the BIP application, Turkey's local communication platform.
- AFAD announced that 32,763 of the 56,293 people quarantined in the dormitories were discharged.
- The relocation of Turkish citizens, who were temporarily in Germany and stranded due to the Covid-19 pandemic, was reported to be completed.
- 155 Turkish citizens brought from Switzerland to Turkey as part of the measures against Covid-19 were placed in a student dormitory in Amasya.
- 299 Turkish citizens brought from Azerbaijan to Nevşehir Kapadokya Airport as part of the Covid-19 measures were taken by land from there to Niğde.
- The Adalar District Governorate declared that due to the Covid-19 pandemic all entrances into and exits from the district would be suspended between Sunday, April 26, 24:00, and May 31, 24:00, excluding those with exceptions.

# Measures Taken

## APRIL 25

○ President of TÜBİTAK Prof. Hasan Mandal stated that the platform, consisting of a total of 41 institutions, 25 of which are universities, would reach the stage of drug development in summer months the latest and that the pre-clinical stage of vaccination would be completed within nine months.

○ As part of efforts to evacuate 25,000 Turkish citizens living abroad, a total of 1,093 Turkish citizens were brought to Turkey from Morocco, Italy, Kazakhstan, Singapore, Malaysia, and the United States on April 24 and 25, 2020.

## APRIL 26

○ Turkish citizen Emrullah Gülüşken, whose Covid-19 test came positive but was sent home without any treatment in Sweden, and his three children were brought to Turkey by an air ambulance sent to Sweden.

○ Registration procedures for address notification between the provinces were ceased by the Ministry of Interior Directorate General of Population and Citizenship Affairs until May 11 as part of the fight against coronavirus pandemic.

○ According to the "Novel Coronavirus Information Guide" sent by the Ministry of Family, Labour and Social Services General Directorate of Disabled and Elderly Services to the relevant institutions, all personnel who go to work within the framework of the 14-day shift system would be tested for Covid-19.

○ As part of the measures against Covid-19, 454 Turkish citizens were brought from Qatar to Turkey.

## APRIL 27

○ In his statement after the Cabinet Meeting, President Recep Tayyip Erdoğan announced the following:

■ A curfew will be imposed in 30 metropolitan cities and Zonguldak on May 1, 2, and 3, 2020.

■ The weekend curfews will continue until after the Eid al-Fitr.

■ On May 1, 2020, the markets will be open between 09:00 and 14:00.

■ Adjudgments regarding cases, enforcement, complaints, appeals, and notice periods in courts will be extended until June 15.

■ 1,000 TL will be given to anyone who applies and is found to be in need without seeking any prerequisites.

## MEASURES TAKEN

## APRIL 28

- The measures against Covid-19 introduced at centres for organ and stem cell transplantation were revised.
- As part of new measures taken in international commercial transportation, the following was announced;
  - With the exception of the Iraqi and Iranian border gates, Turkish drivers who do not have Covid-19 symptoms could travel abroad before the quarantine period expires.
  - Priority will be given to the entry of vehicles carrying medications, medical supplies, and foodstuffs, which are of vital importance to Turkey.
- Ministry of Interior announced that in the last 42 days, 402 of 855 suspects, who have shared unsubstantiated and provocative posts about Covid-19 on social media, were detained.
- As part of coronavirus measures, Istanbul-Adalar ferry services began in a controlled manner.
- 618 Turkish citizens were brought to Turkey from Saudi Arabia and Qatar as part of the fight against Covid-19.
- 454 Turkish citizens brought from Qatar and 39 from Iran were placed in dormitories in Manisa, Çankırı, and Mardin.
- Ministry of Interior sent a circular to 81 Provincial Governorates regarding the curfews to be imposed on May 1, 2, and 3.
- Turkish Airlines extended the decision to suspend flights until May 28 as a result of the Covid-19 pandemic.
- The first patient to receive plasma therapy for Covid-19 in Turkey recovered.
- Haluk Hasan Seyithanoğlu, a medical student in Russia with lung disease, was brought to Turkey by an air ambulance.
- 171 Turkish citizens brought from Saudi Arabia to Denizli within the scope of the fight against Covid-19 were quarantined in a dormitory.
- 151 Turkish citizens evacuated from Mali and Niger due to the Covid-19 pandemic were placed in dormitories in Erzurum.

# Measures Taken

## APRIL 29

- The Ministry of Interior sent a circular to provinces regarding the curfews to be imposed between April 30, 24.00, and May 3, 24.00 in 31 provinces.
- 87 Turkish citizens who were brought to Turkey from India were quarantined in Izmir.
- 272 Turkish citizens who were brought to Turkey from Kenya and Tanzania were quarantined in Samsun.
- 118 Turkish citizens brought from Bosnia and Herzegovina and Croatia were placed in dormitories in Erzurum.

## APRIL 30

- The Ministry of National Education announced that as part of the novel coronavirus measures distance learning would continue until May 31.
- It was announced that May 1st would be celebrated online this year as part of the coronavirus measures.
- "COVID-19 Scientific Research Evaluation Commission" was established within the General Directorate of Health Services of the Ministry of Health.
- The Executive Order, which extended the shutdown period introduced to prevent loss of rights in the field of justice due to coronavirus to June 15, 2020, was published in the Official Gazette.

## MAY 1

- Disaster and Emergency Management Authority (AFAD) announced that the total number of people quarantined in the dormitories as part of coronavirus measures was 65,511.
- The Ministry of Justice announced that the measures taken in prisons due to COVID-19 were extended until May 15, upon the advice of the Coronavirus Scientific Board.
- The Ministry of Health announced that it has updated the methods for controlling infections in the operating rooms.

## MEASURES TAKEN

## MAY 2

○ The Ministry of National Education announced that EBA Assistant applications were introduced with artificial intelligence in order to overcome the problems experienced in the distance learning process and that application for contract teaching to be made in June would be completely carried out electronically.

## MAY 3

○ It was announced that the restriction of entries to and exits from 30 metropolitan cities and Zonguldak was extended until May 4, Monday, 24:00.

○ The Ministry of Health updated the measures applicable to pathology laboratories as part of the fight against the novel coronavirus.

○ 675 Turkish citizens evacuated from Saudi Arabia were placed in quarantine at dormitories in Balıkesir, Çorum, Nevşehir, and Malatya.

## MAY 4

○ In his statement after the cabinet meeting, President Recep Tayyip Erdoğan announced the following;

■ Those above 65 years of age were allowed to go out in one of the curfew days and for 4 hours,

■ Those in the 0-14 age group were allowed to go out on a weekday, on May 13, Wednesday, between 11:00 and 15:00, restricted to walking distance; and to those in the 15-20 age group were allowed to go out for fresh air and rest on May 15, Friday at the same time and under the same conditions.

■ The entrance and exit restrictions for provinces was lifted for Antalya, Ayden, Erzurum, Hatay, Malatya, Mersin and Muğla provinces, in the first phase,

■ The shopping centres would start to serve from May 11, provided that they follow the necessary rules,

■ The even-odd system according to the last digit on the registration plates of commercial taxis in İstanbul, Ankara, and İzmir was lifted as of May 5,

■ Businesses such as barbershops, hairdressers, and beauty salons might start operating on May 11, provided that they follow the necessary rules and measures,

# Measures Taken

## MAY 4

- Military discharges will begin on May 31, the appointment, assignment and personnel recruitment to the Ministry of National Defence would restart on June 1, summons procedures would restart on June 5, and the paid military service procedures would restart on June 20,
- The hard bread wheat purchase price of Turkish Grain Board would be increased from 1,350 TL to 1,650 TL per ton; that farmers would receive 230 TL of premium and support payments per ton for cereals; that the purchase prices of pulses per ton were determined as 3,500 TL for red lentil, 3,200 TL for green lentil and 3,350 TL for chickpea.
- The universities would be able to resume the academic calendar on June 15,
- Regarding the Higher Education Institutions Examination (YKS) in 2020, the students would be exempted from an important part of the curriculum, the duration of the exam would be increased, and the score threshold needed to choose a graduate program through central placement was lowered down to 170 from 180, provided that it would only apply to this year's examination.
- A decision was taken to implement a lockdown between May 9 and 10, 2020,
- The entrance and exit restrictions imposed on 23 metropolitan cities and Zonguldak were extended for 15 days.
- 169 Turkish citizens who were brought to Turkey from Saudi Arabia were quarantined in İzmir.
- 122 Turkish citizens who were brought to Turkey from Burkina Faso and Guinea were placed in student dormitories in Bornova and Buca districts of İzmir to be quarantined for 14 days as part of the novel coronavirus measures.
- The Information Technologies and Communications Authority announced that the contactless delivery system, which was introduced on e-trade platforms, would continue until June 30.
- The Ministry of National Education announced that a booklet had been prepared to promote children's adaptation by helping them understand and express their emotions during this period of the global pandemic.

## MEASURES TAKEN

MAY 5

● The Ministry of Health announced that within the framework of infection control measures, the measures set out for airline companies and flight crews carrying cargo abroad as part of the measures to be taken in international cargo flights would be revised.

- The Ministry of Health revised the measures for travelling, accommodating, and meeting the basic needs of seasonal agricultural workers as part of the novel coronavirus infection control measures.
- The measures for the care of pets during the pandemic period were revised by the Ministry of Health and published on the Ministry's website.
- 245 Turkish citizens brought to Turkey from Belgium and quarantined in a student dormitory in Gümüşhane as part of the COVID-19 measures, were discharged.
- The 55-year old Mehmet Hanefi Ayden, whose COVID-19 test came positive but was sent home without any treatment in Khartoum, the capital of Sudan, was brought to Turkey by an air ambulance of the Ministry of Health.
- The Centre of Assessment, Selection, and Placement (ÖSYM) announced the measures taken as part of the fight against novel coronavirus for the Higher Education Institutions Examination (YKS) and other examinations in 2020. In this context, the following was announced:
  - Exam officers would distribute masks and disinfectants to candidates at the entry of examination buildings,
  - The candidates could bring their own disinfectants and/or colognes with them,
  - Masks and disinfectants would be distributed to exam officers,
  - Only the candidates and exam officers would be allowed into schoolyards to prevent crowds in there and to make sure social distance was maintained,
  - Candidates would be guided by exam officers to maintain social distance while entering the examination buildings,
  - The seating in the examination halls would be arranged in a way to maintain social distance as much as possible.

# Measures Taken

## MAY 6

- In a statement issued following a meeting of the Scientific Board, Minister of Health Fahrettin Koca stated the following;
  - During the first stage of the fight against the pandemic, the goal was to contain the disease, during the second stage that was reached, called the 'Controlled Social Life' the goal was to remove the opportunities before the pandemic and to reshape life.
  - The maximum price would be determined for mask sales and the Ministry of Trade would make the necessary arrangements,
  - Guidelines would be issued for each occupational group; providing the rules that businesses and individuals must comply with when visiting a hairdresser, barbershop, or clothing store, and these guidelines must be posted on their websites and placed in the businesses concerned.
  - Test capacity would be increased,
  - No decision has been taken to open restaurants, diners, and cafés.
- The Ministry of Interior sent a circular on the issue of "Reopening of Barbershops/Beauty Salons/ Hairdressers" to 81 provincial governorates.
- The Ministry of Interior sent a circular to 81 provincial governorates regarding the exemptions from curfew for citizens aged 65 and over, those with chronic illnesses and those under the age of 20.
- 340 Turkish citizens in Kuwait were brought to Turkey and placed in dormitories as part of the novel coronavirus measures.
- It was announced that the Turkish citizens who had to remain in Argentina due to the measures taken against the COVID-19 pandemic would be brought back to Turkey by a special flight.
- 209 Turkish citizens who were brought from the Maldives to Turkey were placed in dormitories in Kırşehir to be quarantined.

## MEASURES TAKEN

## MAY 7

President of the Turkish Football Federation (TFF) Nihat Özdemir announced that the football leagues that were suspended due to the novel coronavirus pandemic would start on June 12-13-14.

- Turkish Airlines announced that as part of the measures against COVID-19, bringing non-domesticated animals from abroad into Turkey along with passengers or by cargo has been prohibited until further notice.
- 574 Turkish citizens, who had been brought to Sivas from Germany and Austria, were allowed to return home after their quarantine period ended.
- Turkish citizens who wished to return to Turkey from Argentina and Brazil were brought to Istanbul.
- It was announced that the Education Information Network and EBA TV would remain on-air throughout the summer holiday.
- 655 citizens who were brought to Adiyaman from Saudi Arabia and Algeria and quarantined in dormitories affiliated with the Credit and Hostels Institution as part of the novel coronavirus measures, were discharged after their surveillance period ended.
- 182 Turkish citizens brought to Erzurum from Saudi Arabia were discharged after their quarantine period ended.

## MAY 8

- Vice President Oktay announced that they worked on a normalization plan and that every step of the plan would be announced weekly by President Recep Tayyip Erdoğan.
- The Ministry of Interior sent a new circular on “commercial taxis” to 81 provincial governorates, specifying the hygiene measures.
- The Ministry of Interior sent a new circular on “Market Places” to 81 provincial governorates. With the circular, the decision taken to restrict the sale of clothing, toys, flowers, seedlings, and house wares in markets, was lifted as of May 11.
- Within the scope of the novel coronavirus measures, wearing masks was made compulsory in Bartın as of May 11.

# Measures Taken

## MAY 8

- At Taksim Square and Istiklal Avenue, wearing masks and a social distance of 3 meters between people was made compulsory.
- The Ministry of Environment and Urbanization warned the citizens that, during the novel coronavirus pandemic, they should double-bag and store their masks and gloves for at least 72 hours before disposal.
- The Ministry of Family, Labour and Social Services announced that visitors would not be allowed into nursing homes and care centres for the disabled on Mother's Day and Eid al-Fitr.
- With the circular issued by the Presidency, legislative studies have been initiated so that the flexible or remote working arrangement, introduced in public institutions, can be applied under the same conditions in all institutions.
- A guideline was prepared by the Ministry of Health, containing measures to be applied in barbershops, hairdressers and beauty salons to reopen on May 11.
- The Ministry of National Education stated that students would be given a separate mask for each session in the central examination on June 20 within the scope of the High School Entrance Exam (LGS).
- The Ministry of National Education regulated the principles regarding distance education, compensatory education, suspending education, passing a grade level, and evaluating student success in emergencies by amending the Regulation on Pre-school Education and Primary Education Institutions.
- A guideline on the measures to be taken in the sectors that will start to serve in the normalization process was prepared by the Ministry of Health.
- 209 Turkish citizens were brought from the Maldives to Ankara as part of the measures against COVID-19.

## MEASURES TAKEN

## MAY 9

○ Lockdowns were imposed in 24 provinces on May 9 and 10 as part of the novel coronavirus measures.

## MAY 10

○ Minister of Culture and Tourism Mehmet Nuri Ersoy introduced the "Healthy Tourism Certification" prepared as part of novel coronavirus measures.

○ The Governorate of Ayden stated that it was obligatory to wear a mask in the street.

## MAY 11

○ In his statement following the Cabinet meeting, President Recep Tayyip Erdoğan announced the following:

- A limited lockdown would be applied on May 16, 17, 18, and 19,
- Citizens over the age of 65 would be able to go out on May 17, Sunday, citizens aged 20 and younger would be able to go out on May 20, Wednesday, and May 22 Friday, between 11.00-15.00,
- The intercity travel restriction for Adana, Diyarbakır, Mardin, Trabzon, Ordu, Denizli, Kahramanmaraş, Şanlıurfa, Tekirdağ was lifted,
- Hospitals in Yeşilköy and Sancaktepe would be completed until the Eid al-Fitr,
- 2 billion TL has been collected so far under the campaign "We are Self-Sufficient, Turkey".
- Unemployment payments for May were moved to an earlier date,
- Pension payments would start as of May 15 and would be completed by the end of Eid al-Fitr,
- More than half a billion TL in resources have been transferred to the Social Assistance and Solidarity Foundations for Eid al-Fitr aids,

# Measures Taken

## MAY 11

- The fresh tea purchase price for 2020 was determined as 3,27 TL and tea purchases would start with the harvest,
- The amount of Social Security premium payments postponed for 6 months based on force majeure reached 40 billion TL and the social protection shield would be further strengthened.
- Turkish citizens in Ivory Coast and Liberia were brought to Istanbul by a Turkish Airlines (THY) plane.
- Shopping malls and barbershops, hairdressers and beauty salons, whose activities were suspended due to the novel coronavirus pandemic, reopened by taking the necessary measures.
- The isolation room requirement was introduced to the hotels for obtaining certification.
- 5 buildings were quarantined in Şanlıurfa.
- It was announced by the Higher Education Council (YÖK) that university finals and other exams for this academic year would not be carried out face-to-face, that they would be carried out by using alternative methods such as homework, projects or digital means to be preferred by the university competent boards.
- The Turkish Standards Institution (TSE) set the standards for washable cloth masks and published them on the website. TSE standards included all stages from the design and production of the cloth mask to its bacterial filtration efficiency and post-use disposal.
- Turkish Basketball Federation announced that all leagues were terminated without the declaration of a champion and relegation due to the novel coronavirus pandemic.
- Turkish Volleyball Federation announced that the remaining games in the men's and women's leagues would not be played. It was announced that the leagues were registered and there would be no relegation for this season.
- The Ministry of Interior announced that as of May 11, 60,385 citizens who were in quarantine in the student dormitories were discharged.

## MEASURES TAKEN

MAY 12

- The Ministry of Interior sent a circular on “Travel Permit Documents for Tea Manufacturers/Producers” to all governorates. According to the circular, citizens residing in Ankara, Balıkesir, Bursa, Eskişehir, Gaziantep, İstanbul, İzmir, Kayseri, Kocaeli, Konya, Manisa, Sakarya, Samsun, Van, and Zonguldak in which entry/exit restriction was implemented and in provinces where one or more of these provinces were on the travel routes of citizens who are registered tea producers of the General Directorate of Tea Enterprises (Çaykur) would be able to travel to the provinces where the tea gardens are located for the first cut fresh tea harvest of 2020, as of May 19, Tuesday, 12.00, provided that they obtained travel permits.
- The Competition Authority initiated an investigation into 10 enterprises operating in the field of production and sale of medical, protective, and fabric masks due to an average price increase of 600-700 percent during the novel coronavirus period.
- Turkish Handball Federation announced that all the leagues were registered as they stood in the normal season and no champions would be declared in the leagues.

MAY 13

- In his statement following the Coronavirus Scientific Board meeting he attended via video conference, Minister of Health Fahrettin Koca announced the following;
  - The number of filiation teams increased to 6 thousand 239 and, 722 thousand people who had contact with coronavirus patients have been reached since the first case,
  - The number of users of “Life is at Home” application has reached 10 million,
  - Intensive work has been conducted with the Ministry of Culture and Tourism regarding the measures to be taken for tourists coming from abroad,
  - Turkish Statistical Institute (TUIK) would conduct tests for the immunity map, 150,000 people have been identified by sampling method, and antibody testing would also be carried out in addition to the PCR test during this period,
  - Efforts continue to make additional payments to employees of the Family Health Centre.
- The Ministry of Culture and Tourism issued a circular on measures to be taken at accommodation facilities as part of the controlled normalization process in the fight against COVID-19.

# Measures Taken

## MAY 13

- The Ministry of Health issued the guidelines for the COVID-19 measures at the banks. According to this; during the normalization process, the maximum number of customers in the waiting area will not exceed the number of desks, numerators will only be used by a single person wearing a medical mask and will be cleaned properly.
- Guidelines and checklists on measures to be taken at hairdressers and beauty salons, accommodation facilities, and intercity travel by public transport vehicles were issued as part of the fight against coronavirus.
- The Ministry of Youth and Sports announced that this year, due to the novel coronavirus, the May 19 Commemoration of Atatürk, Youth and Sports Day and Youth Week events would be celebrated interactively on digital medium rather than the squares.
- As part of the novel coronavirus measures, wearing masks was made compulsory for everyone going outside as of May 15 in Uşak and Muğla.
- Children aged 14 and younger, who were restricted from leaving their houses due to coronavirus, filled the parks and gardens after a long period.
- Turkish citizens brought by plane from Uzbekistan as part of the novel coronavirus measures were placed in dormitories in Yalova and Düzce.
- 90 Turkish citizens brought from Iraq were placed in a student dormitory in Batman to be kept under surveillance as part of the novel coronavirus measures.
- Youth and Sports Minister Mehmet Kasapoğlu announced that 9,647 citizens were in quarantine in dormitories in 76 provinces and 62 thousand 593 citizens were discharged.

## MAY 14

- As part of the fight against novel coronavirus, wearing masks was made compulsory in 10 provinces in Turkey.
- Salih Kör, a 21-year-old patient with leukemia in the Netherlands, was brought to Turkey for treatment by an air ambulance of Turkey from Rotterdam Airport.

## MEASURES TAKEN

## MAY 15

- As part of the measures taken against the novel coronavirus during the normalization process, guidelines for 13 sectors prepared by the Ministry of Health were published on the website.
- As part of the measures taken against the novel coronavirus, wearing masks was made compulsory in Sakarya, Kayseri, Burdur, and Siirt.
- The Ministry of Justice announced that the measures taken regarding the prisons as part of the fight against the novel coronavirus had been extended until May 30.
- Young people aged 15-20, who were under lockdown due to the coronavirus pandemic, were permitted to leave their homes and go outside between 11.00 and 15.00.
- Wearing masks was made compulsory in streets and open areas in Konya.
- President of Religious Affairs Ali Erbaş stated that the mosques, which were closed to worship as part of the COVID-19 measures, could be reopened as of June 12.
- The Ministry of National Defence announced that discharges would restart as of May 31, summons procedures would restart as of June 5, and the paid military service procedures would restart as of June 20.
- Turkish citizens in TRNC, Hungary, Dominican Republic, El Salvador, and Cuba were brought to Turkey.

## MAY 16

- The Ministry of Interior sent a circular to the governorates to inspect whether the COVID-19 measures were complied with in barbershops, hairdressers, taxis, market places, and public transportation vehicles. In 81 provinces, inspections were carried out to determine whether the barbershops, hairdressers, shopping malls, market places, and intercity public transportation services complied with the measures taken. Judicial or administrative action was taken against 4,368 individuals who violated the social distancing and restriction rules.
- The Ministry of Health prepared the guidelines, in line with the recommendations of the Coronavirus Scientific Board, regarding the measures to be taken in the sectors that would start to provide services as part of the controlled normalization process in the post-COVID-19 period.

# Measures Taken

**MAY 16**

- As part of the normalization process, the Ministry of Health prepared a guideline titled "Measures Regarding Haberdashery Stores, Clothing Shops and Variety Stores", in line with the recommendations of the Coronavirus Scientific Board.
- The aircraft carrying Turkish citizens who wished to return home from Hungary due to the novel coronavirus pandemic arrived in Istanbul. Passengers arriving in Turkey were taken to dormitories in Düzce to be quarantined after the medical examination by the healthcare personnel.

**MAY 17**

- The Disaster and Emergency Management Presidency (AFAD) stated that 65 thousand 243 people out of 74 thousand 898 people who were quarantined in the dormitories were discharged.
- The Ministry of Interior sent a circular titled "Traffic Measures for the Summer Season" to 81 governorates. The 50 percent-occupancy criteria and mask wearing in public transport vehicles and buses would be meticulously followed within the scope of traffic measures to be implemented between June 1 and October 1. During the audits, attention would be paid to the social distancing rule while the drivers and passengers would be informed and warned. In order to minimize possible accidents, traffic controls for all passengers and drivers would be increased in July and August when the holiday season is the busiest. There would also be no permission for intercity travel between 00:00 and 06:00 for vehicles carrying seasonal agricultural workers.
- Minister of Trade Ruhsar Pekcan announced that fairs would be organized on virtual medium.

**MAY 18**

- In his statement following the Cabinet Meeting, President Recep Tayyip Erdoğan announced the following:
  - A curfew would be imposed between 23 and 26 of May.
  - Citizens aged above 65 would be able to go out on Sunday, May 24, between 14.00 and 20.00.
  - The new education year for schools affiliated to the Ministry of National Education would start in September.
  - On Friday, May 29, with the Friday prayer, the mosques would be opened for worship, starting with the mosques whose conditions were suitable.

## MEASURES TAKEN

## MAY 19

- Intercity travel restriction applied in 15 provinces was extended for 15 days.
- As part of the measures taken against the novel coronavirus, wearing masks was made compulsory in Bolu.
- 288 of the 296 Turkish citizens who had been brought from the USA were placed in a dormitory located in Trabzon.
- President Recep Tayyip Erdoğan met with young people and athletes from different provinces in Turkey through a video conference, which was also attended by Minister of Youth and Sports Mehmet Muharrem Kasapoğlu, on the occasion of May 19 Commemoration of Atatürk, Youth and Sports Day.
- As part of measures against the novel coronavirus, wearing masks was made compulsory in İzmir and Kocaeli.
- The Ministry of Interior sent an additional circular to 81 governorates regarding measures on entries to and exits from cities.
- The Ministry of Interior sent a circular to 81 governorates regarding the "curfew".
- Minister of Culture and Tourism Mehmet Nuri Ersoy sent a circular regarding the booking procedures in facilities to the 81 provincial Directorates of Culture and Tourism along with the Turkish Hoteliers Federation, Turkish Hotelier Union, and Turkish Tourism Investors Association. According to the circular, legal action would not be applied for bookings made before December 31, 2020, or other activities that do not include accommodation before the same date are cancelled by the facilities.

## Measures Taken

MAY 20

- As part of the fight against the novel coronavirus wearing masks was made compulsory by general hygiene boards of 25 provinces. In terms of metropolitan cities, besides Ayden, Balıkesir, Denizli, Eskişehir, Kahramanmaraş, Kocaeli, Konya, Muğla, Sakarya and Şanlıurfa, wearing masks was made compulsory in Adıyaman, Afyonkarahisar, Amasya, Bolu, Bartın, Burdur, Düzce, Isparta, Gümüşhane, Karabük, Kastamonu, Kırklareli, Rize, Siirt and Uşak as well. In addition to 25 provinces, where going out without wearing a mask was prohibited, wearing masks was made compulsory in İzmir, Gaziantep, Giresun, Karaman, Kayseri, Ordu, Trabzon, Tunceli, Van, Kırıkkale and for some streets in the centre and certain districts of Manisa as well as in Tatvan, Bitlis and Bozcaada and Gökçeada, Çanakkale.
- Turkish citizens stranded in Chile due to the measures against the novel coronavirus set out to return to Turkey.

MAY 21

- The Ministry of Health introduced the “Life is at Home (HES) code” application for controlled social life.
- The Ministry of Culture and Tourism issued a circular, which set out the measures to be observed at detached eating-drinking venues as part of the controlled normalization process, to be put into practice on the date to be determined by the Ministry of Interior.
- The issues regarding the travel permission of the citizens aged 65 and older were determined by the circular sent to 81 governorates by the Ministry of Interior. According to the circular, the citizens aged 65 and older were permitted to travel to any place of their preference on condition that they would obtain travel permission and remain at their place of destination for no less than 30 days.
- As part of the “Safe Tourism Certification Program”, one of the first examples in the world launched under the coordination of the Ministry of Culture and Tourism, eligibility criteria to obtain the certificate and the accreditation bodies approved by the Turkish Accreditation Agency were determined.
- Wearing masks in open areas was made compulsory in Mardin as part of the fight against COVID-19.
- The High Board of Religious Affairs under the Presidency of Religious Affairs announced that the Ramadan Eid prayer would not be performed in mosques due to the novel coronavirus.
- The Ministry of National Education announced that the Scholarship Exam for Primary and Secondary Schools (IOKSB) was postponed to September 5, 2020.

## MEASURES TAKEN

## MAY 22

- The posters and brochures published on the website of the Ministry of Health included hygiene measures to be applied at taxi stops and warnings for drivers and customers.
- As part of the measures against COVID-19, wearing masks was made compulsory by the Provincial General Hygiene Boards in Iğdır and Zonguldak.
- 294 Turkish citizens brought from the USA and placed into quarantine in dormitories in Isparta and Burdur, as part of the measures against the novel coronavirus, were sent off to their homes.
- 233 of 276 people who were brought to Çankırı from Kuwait and placed into quarantine were sent off to their homes.
- 156 people who were brought to Yalova from Uzbekistan and placed into quarantine were sent off to their homes.

## MAY 23

- All works and procedures as part of the assignments made due to the pandemic in the units affiliated to public and private healthcare institutions and organizations were included in the scope of the policy "Compulsory Financial Liability Insurance for Medical Malpractice".
- The Ministry of Interior submitted a circular on "Traffic Measures on Eid al-Fitr" to 81 governorates.
- Minister of Youth and Sports Mehmet Kasapoğlu stated that there was no one in the dormitories of the Ministry of Youth and Sports, which hosted citizens returning to Turkey were quarantined as part of the measures against coronavirus, and 77 thousand 441 people had stayed in dormitories in 76 provinces since the beginning of the quarantine.

## MAY 24

- Turkish citizens living in Bangladesh, who had been diagnosed with coronavirus but could not be treated in the country, were brought to Istanbul by an air ambulance sent by the Ministry of Health.
- Minister of Transport and Infrastructure Adil Karaismailoğlu announced that High-Speed Train services would resume en route Ankara-İstanbul, Ankara-Eskişehir, Ankara-Konya, Konya-İstanbul, making a total of 16 rounds and the sale of the tickets would begin on the second day of Eid al-Fitr.

# Measures Taken

## MAY 26

- As part of the measures against the novel coronavirus, it was prohibited to go out to streets without a mask in Elazığ as of May 27.
- Turkish National Police warned that people who said they were from the Ministry of Health and would provide information about or screen for coronavirus should not be allowed in.
- Presidency of Religious Affairs issued a warning poster regarding Friday prayers. People were urged to take ablution at homes and workplaces, wear a mask, bring a prayer rug and not to ignore social distancing as part of Friday prayers to be performed as of May 29 at the mosques with a convenient garden, courtyard and outdoor area.
- In line with a circular by the Ministry of Interior, quarantine in 395 locations in 63 provinces was lifted.
- The Council of Higher Education designated the basic principles of end-of-term exams to be held digitally at universities.

## MAY 27

- The guidelines prepared in compliance with suggestions made by the Coronavirus Scientific Board of the Ministry of Health as part of controlled normalization process in the wake of COVID-19 were compiled, and measures to be taken for 11 sectors were also determined.

## MAY 28

- President Recep Tayyip Erdoğan made the following statement following the Cabinet meeting:
  - Intercity travel ban had been completely lifted as of June 1,
  - Employers over the age of 65 would be able to start working, provided that they complied with the mask, distance and hygiene requirements,
  - Civil servants, who were on administrative leave or involved in the flexible working system, would go back to the regular schedule as of June 1,
  - All kindergartens and day-care centres would open on June 1,

## MEASURES TAKEN

- The lockdown on citizens aged 65 and over with the exemption on Sundays between 14:00-20:00 would continue,
- As of June 1, businesses such as restaurants, cafés, patisseries, coffee houses, tea gardens, clubhouses, swimming pools, hot springs would start serving until 22.00 within the limits of determined rules, and the entertainment venues and water-pipe sales were outside this scope,
- Roadhouses would continue to serve on June 1,
- Beaches, national parks, and gardens would be operational as of June 1 within the limits of determined rules,
- Museums and ruins would open on June 1,
- Livestock markets would be operational again as of June 1 and hippodromes as of June 10,
- Sports facilities and the premises within them would be able to serve until 24:00,
- The restrictions on sea tourism, fishing, and transportation were lifted within the limits of determined rules,
- The courses like driving courses would be allowed to provide service as of June 1,
- Libraries, nation's coffee houses, youth centres, and youth camps will be able to continue their activities within the limits of terms set out as of June 1,
- Concerts at venues with outdoor seating facilities would be allowed until 24:00.
- 75 thousand Turkish citizens had been brought from 126 different countries to Turkey by 365 air, 34 land, and 10 sea trips,
- The pharmaceutical factories of the Ministry of National Defence also started manufacturing besides the production of medications and devices needed for the treatment of the disease and their supply from abroad as well as the support of the private sector,

# Measures Taken

## MAY 28

- The production of ventilators had been sustained through the private sector and the Machinery and Chemical Industry Corporation, and 1,000 out of 3,626 ventilators had been exported.
- The Ministry of Interior sent a circular to 81 governorates regarding "Lockdown for People under the age of 18 and over the age of 65."
- It was stated that the train journeys which had been suspended due to COVID-19 were resumed.
- It was stated that congregational prayer, which had been suspended as part of the measures against coronavirus, would resume with the Friday prayer to be performed by President of the Religious Affairs Ali Erbaş at Fatih Mosque.
- General Directorate of Health Services of the Ministry of Health sent a circular titled "Measures to be taken for Patients and Patient Relatives to Visit Turkey during the COVID-19 Pandemic as part of International Health Tourism" to the International Health Services Inc. (USHAS) and 81 governorates.
- As part of measures against the novel coronavirus, Ankara Provincial Office of Mufti stated that the places to perform Friday prayers in the city were designated and a single-use prayer rug and mask would be distributed to those who would go to the mosques to be opened to worship on Friday in the capital.

## MAY 29

- It was stated that the ban on visiting the GNAT campus had been extended until June 30.
- In a statement, Minister of Justice Abdulhamit Gül noted the following;
  - Non-contact jail visits, which had been postponed due to the novel coronavirus pandemic, would resume as of June 1,
  - Hearing rooms would be sterilized in accordance with sanitary requirements,
  - Temperatures of individuals entering courthouses would be taken and those with a body temperature higher than 38 degrees would be referred to a healthcare institution,
  - The number of people to enter the courthouses and the audience to be allowed into courtrooms would be designated, taking into account the rules of social distancing,
  - The work was underway to allow prisoners to hold video calls with their relatives, the pilot scheme would be initiated and digital means would be used in censuses in prisons.
- A circular issued by the Ministry of Interior stated that the lockdown on young people aged 18-20 had been lifted.

## MEASURES TAKEN

MAY 30

- The Supreme Board of Judges and Prosecutors (HSK) announced its action plan to return to normal in the judiciary. The HSK stated that the trials and discoveries in ordinary and administrative courts of the first instance would start on June 16 and the appeal and tax courts would initiate all judicial activities on June 1.
- The Ministry of National Education announced that the private preschool education institutions and various courses such as foreign language, computer, and driving courses would be opened as of June 1.
- Antibacterial, highly breathable, and water repellent masks, which are durable to wash for 25-30 times, were produced by a textile company in Bursa and sent to the teams of the world's leading football (Bundesliga and La Liga) and basketball (NBA) leagues.

- The Ministry of Interior sent a circular to 81 governorates with regard to "Travel Restrictions in/out of Cities." In this framework,
  - The obligation to obtain a travel permit certificate has been abolished when travelling by intercity public transport vehicles.
  - Children that are younger than 18 and under lockdown will be able to travel in and between cities with their parents.
  - As part of travels by vehicles such as airplanes, trains, and buses, tickets will be purchased after receiving a code through the HES application.
  - The restriction on entering/exiting 14 provinces with metropolitan status and Zonguldak will be lifted on Sunday, May 31 at 24:00.
- A circular was issued by the Ministry of Interior regarding businesses such as restaurants, diners and cafés, and also parks, picnic sites, recreation areas, and cloth markets. In this framework,
  - Restaurants, diners, cafés, patisseries, coffeehouses, tea gardens, and clubhouses will be back in service until 22:00 as of June 1.
  - Businesses such as swimming pools, hot springs, Turkish baths, saunas, SPA centres, etc. will be back in service until 22.00 and sports centres/facilities until 24.00 in line with the rules determined as of June 1.

## Measures Taken

MAY 30

- In public places of recreation and entertainment, which will be back in service on June 1, playing cards, rummikub, and backgammon will not be allowed, and also water pipe will be forbidden.
- Picnics, sports, hiking, sightseeing, fishing, and similar activities (except for barbecues) will be allowed at parks/gardens, recreation and picnic areas, resorts and ruins, and coastlines as of June 1.
- Live music events for dance purposes that are likely to cause direct contact at public recreational and entertainment areas will not be organized.
- The activities at all markets, especially that are designated as cloth markets (high-end flea markets), and stalls, where activities were temporarily suspended and where non-essential items such as clothing, toys, ornaments, bags, etc., are sold, will start on Monday, June 1, 2020, by observing the rules and social distancing requirements that are determined.
- President of YÖK Prof. Yekta Saraç said in a written statement that a series of decisions had been made regarding the students studying abroad, who were unable to return to universities they attended due to the COVID-19 pandemic or who were not willing to go back to the university they attended due to the risks regarding the pandemic in the country where they studied.

MAY 31

- Curfews and travel restrictions imposed in 14 metropolitan cities and Zonguldak as part of the fight against novel coronavirus ended at 24:00.
- It was announced that the flights, which were gradually suspended in March as part of the measures against COVID-19, would resume as of June 1 at Esenboğa Airport, which was issued "eligible for flight certificate".
- The postponed discharge procedures at the Turkish Armed Forces were initiated again.

## MEASURES TAKEN

## JUNE 1

- As part of the measures against COVID-19, 11,066 tea producers and workers coming from other provinces to Rize were tested.
- The chapters titled "Measures to be Taken in Libraries", "Measures to be Taken Regarding Cafés and Coffeehouses" and "Working in Healthcare Institutions in the Normalization Process during the COVID-19 Pandemic" were included in the "Pandemic Management and Working Guideline," which was updated by the Ministry of Health.
- A Turkish citizen, who was living in Russia and diagnosed with the novel coronavirus, was brought to Adana by an air ambulance sent by the Ministry of Health when his condition worsened.
- The Historic Grand Bazaar and the Spice Bazaar, which were temporarily closed on 24 March, started to serve again.

## JUNE 2

- The public banks announced that companies that reflected their financing support on customers as a price increase in their products and services would be excluded from the scope of the loan package.
- The Ministry of Family, Labour, and Social Services determined the measures to be implemented at public institutions and agencies after the flexible working model introduced on March 22 in the public sector due to the COVID-19 pandemic had ended.
- It was announced that a neighbourhood in Pazarcık, Kahramanmaraş was quarantined as part of coronavirus measures.
- Libraries and coffee houses were reopened in line with the measures taken during the normalization process.
- It was stated that Turkish Airlines would have direct flights from 16 cities in 6 European countries to 14 destinations in Anatolia.
- Circular regarding intracity passenger transportation was sent to governorates by the Ministry of Interior.
- Ministry of National Education Directorate General for Private Education Institutions announced that private schools would continue providing distance education until June 19, and provide face-to-face remedial training after August 15 that will last at least 3 weeks.
- As part of the novel coronavirus measures, non-contact jail visits suspended as of 13 March began yesterday.
- Selda Gül Ekenel, who lived in the capital Oslo of Norway and had a brain tumour, was brought to Turkey for treatment by an air ambulance of Turkey from Oslo Airport.

# Measures Taken

## JUNE 2

- Turkish Consulate General in Chicago announced that a special flight would be operated for the Turkish citizens in the United States on June 3 from O'Hare Airport to Turkey.
- Turkish Airlines announced that a special flight would be operated on Thursday, June 4 from Toronto to bring Turkish citizens living in Canada.

## JUNE 3

- The Ministry of National Education announced that face-to-face remedial, completion and compliance training for official educational institutions would start on Monday, August 31, and would last for three weeks.
- As part of the measures against COVID-19, wearing a mask covering the mouth and nose in public areas was made compulsory throughout the province of Kütahya.
- As part of the measures against the novel coronavirus, Turkish Airlines started to provide "hygiene kit" for its passengers during all flights and to designate "hygiene expert" cabin crews responsible for the proper implementation of the necessary hygiene measures throughout the flight.

## JUNE 4

- The Ministry of Interior announced that the judicial and administrative fines were imposed on 496 thousand 841 people, who did not obey the coronavirus measures; and the judicial and administrative fines were imposed on 601 people and 7 of them were arrested during the operations carried out by law enforcement officers.
- The measures against COVID-19 were set out for hot springs, saunas, jacuzzis, and indoor pools.
- The measures against COVID-19 were set out for the seaside and beaches, hand-line fishing, and walking areas.
- Roadside restaurants and cafes, which were on intercity travel routes within Ankara, were allowed to be kept open all the time.

## MEASURES TAKEN

## JUNE 5

- “Measures to be taken at Camps under the Ministry of Youth and Sports” was included in the “Pandemic Management and Working Guideline” updated by the Ministry of Health.
- 295 Turkish citizens, who could not return to Turkey when the flights were suspended due to the COVID-19 pandemic, were brought to Turkey by a special flight of Turkish Airlines from O’Hare International Airport in Chicago.
- 4 Turkish citizens stranded in Uruguay, a South American country, due to the coronavirus pandemic, which affected the whole world, departed from Montevideo to return to Turkey.

- Minister of Transport and Infrastructure Adil Karaismailoğlu announced that 47 more airports were entitled to receive certificates.
- A neighbourhood in Çubuk, a district of Ankara, was quarantined as part of the measures against the novel coronavirus.

## JUNE 6

- The Turkish Embassy in Washington announced that a special flight would be operated for Turkish citizens in the United States on June 10 from Los Angeles International Airport to Istanbul.
- The Ministry of Health stated that posters were designed in line with the guidelines prepared specifically for the service sector according to the recommendations of the Coronavirus Scientific Board.
- Minister of Family Labour and Social Services Zehra Zümrüt Selçuk announced that the ‘Day Care Centres’ in 75 provinces would reopen as of July 1 with the normalization process.

# Measures Taken

## JUNE 7

- As part of the measures against the novel coronavirus, a building with 10 apartments was quarantined in Izmit district of Kocaeli.
- It was announced that the face-to-face education for the Qur'an courses and all other training programs, which were suspended by the Presidency of Religious Affairs as part of the measures taken against the COVID-19 pandemic, would restart in the normalization process.

## JUNE 8

- As part of the novel coronavirus normalization process, measures regarding patient visits, medical reports, and healthcare personnel were revised by the Ministry of Health. General Directorate of Health Services of the Ministry of Health sent a letter regarding "COVID-19 Normalization Process and Measures to be Taken" to 81 governorates as well as all healthcare institutions and organizations.
- The Social Sciences Board, which would work in fields such as sociology, communication, psychology, sociology of religion, statistics in the COVID-19 pandemic, convened under the chairmanship of Minister of Health Fahrettin Koca.
- The Ministry of National Education decided to hold face-to-face and online occupational summer programs for approximately 1 million teachers between June 22 and 30 as part of the normalization process.
- Turkish Airlines stated that a special flight was operated to bring Turkish citizens from Canada.
- Minister of Industry and Technology Mustafa Varank stated that more than 1,500 intensive care ventilators were delivered to Brazil, and thus approximately 2,000 devices were sent abroad.

## MEASURES TAKEN

## JUNE 9

○ The Presidential Cabinet convened under the chairmanship of President Erdoğan. After the cabinet meeting, President Erdoğan expressed the following:

- The health army, including nearly 1 million 100 thousand healthcare professionals from doctors to nurses and from technicians to janitors, was at the service of 83 million citizens,
- Closing hours of businesses such as restaurants, cafes, and coffee houses were extended from 22.00 to 00.00,
- Businesses such as cinemas, theatres, and show centres would operate again as of July 1, in line with the determined rules,
- Citizens over the age of 65 could go out between 10.00 and 20.00 every day of the week,
- The restriction regarding those younger than 18 was completely lifted provided that minors were accompanied by their parents,
- National parks and nature parks would be free of charge for the healthcare personnel, and the citizens under the age of 18 and over 65,
- The marriage offices would start serving as of June 15 and the wedding halls as of July 1 in line with the determined rules,
- To date, the number of countries, whose medical aid demand was met and to which the import permission was granted, reached 125,
- The drug Favipiravir, used effectively by our physicians in the treatment of COVID-19, was produced with our own synthesis by scientists working under the TÜBİTAK.
- In the last 3 months, 5.5 million families were provided 1000 TL of cash support,
- Public banks introduced low-cost financing supports with easy to satisfy application requirements to meet the need for cash,
- In order to protect the employees, it was forbidden to lay off workers and the salary burden of businesses was reduced with short-term working allowance,

# Measures Taken

## JUNE 9

- Since March, more than 3 million people had benefited from short-term working allowance and approximately 5 billion TL had been paid within this framework.
  - Employees who were on unpaid leave and who could not receive unemployment benefits started to receive monthly cash support payments of 1,177 TL.
  - Financial support of 40 billion TL was provided to 6.7 million citizens whose income was less than 5 thousand TL.
  - Financial support of 27 billion TL was provided to 1 million 300 thousand tradesmen by Halkbank,
  - The financial allocation of more than 154 billion TL was made to 197 thousand enterprises, 97 percent of which were of SMEs,
  - Investment incentive loans of 20 billion TL were taken out for the companies in strategic areas,
  - A system would be established to provide tradesmen, small businesses, investors with affordable and long-term resources for production and employment,
  - Arrangements to make our labour market more efficient for partial or flexible working schemes would be implemented,
  - After rapidly implementing Employment Shield, Turkey would put the supplementary pension system into force in 2022.
- It was stated that the robot called "Aerobot", which began to serve at Istanbul Sabiha Gökçen International Airport, warned the passengers about the coronavirus measures as well as giving information about the flights.
  - Turkish citizens in Canada were brought to Istanbul with 4 special flights. The temperatures of 301 Turkish citizens were taken on board with smart helmets worn by the hygiene officers.
  - During the normalization process, the experts of the Turkish Standards Institute (TSI) started to grant "COVID-19 Safe Production Certificate" to the companies inspected for the measures to be taken in industrial facilities.

## MEASURES TAKEN

## JUNE 10

- In line with the decisions taken by the Turkish Football Federation about the matches, the novel coronavirus testing process began for the sports press.
- The chapter "Measures to be taken in the use of parks, gardens, recreation and picnic areas" was included in the "Pandemic Management and Working Guideline" updated by the Ministry of Health.
- The "Pandemic Management and Working Guideline" was updated by the Ministry of Health and the chapter "Measures to be taken in open-air concerts" was included in it.
- The Ministry of Health updated the "Pandemic Management and Working Guideline" and included the measures for livestock sales places before and during the Eid al-Adha.
- The Ministry of Health updated the "Pandemic Management and Working Guideline" and included the chapter "Measures to be taken concerning optical stores".
- The "Pandemic Management and Working Guideline" was updated by the Ministry of Health, and the chapters "Measures to be taken concerning Food Industry and Production Facilities" and "Measures to be taken concerning Non-Food Industry and Production Facilities" were included.
- As part of gradual normalization measures, the Ministry of Family, Labour, and Social Services updated the measures taken at women's shelters where victims of violence or those at risk of violence stay.
- The Ministry of the Interior asked the governorates to take measures at farewell ceremonies for the newly recruited soldiers.
- Turkish citizens in Israel were brought to Turkey by a special flight of Turkish Airlines.
- Minister of National Education Ziya Selçuk sent a letter to the provinces regarding the year-end procedures for the academic year of 2019-2020. The circular clarified the issues regarding promotion to a higher grade at high schools, conditional promotion exams, school reports, and students abroad.

# Measures Taken

## JUNE 11

- As part of the “Community Screening Program” launched by the Ministry of Health and Turkish Statistical Institute (TurkStat) to combat the novel coronavirus, health teams performed the COVID-19 test called PCR with the consent of individuals.
- Ministry of Health announced that antibody testing started in 13 provinces. The aim of the test to be performed nationwide as of June 15 is to create the immunity map of Turkey.
- The Ministry of Family, Labour, and Social Services decided to work on normalization efforts for child-care organizations and family-oriented services for children.
- Minister of Culture and Tourism Mehmet Nuri Ersoy held a meeting with the EU ambassadors via video conference to explain the safe holiday service they have introduced. During the meeting held at the request of the Delegation, Minister Ersoy explained the “Tourism Certification Program” in Turkey to the representatives of EU countries.
- Turkish Airlines announced that it launched scheduled flights from Istanbul Airport to Germany, United Kingdom, and the Netherlands as part of the new steps towards normalization.
- Turkish Airlines operated a special flight for Turkish citizens who were stranded in the USA due to the novel coronavirus pandemic.
- Due to COVID-19, provisions of the circulars regulating the entry into and exit from Turkey by Turkish citizens and foreigners, other than the ones concerning the entry and exit of passengers through Iran land border crossings, were abolished.
- The 32-storey apartment building in Kayseri was quarantined as part of the novel coronavirus measures.
- Seven more households were quarantined in Çayırılı village of Ereğli district in Zonguldak.

## MEASURES TAKEN

## JUNE 12

- Ministry of Commerce amended the regulation, aiming to sustain businesses and transactions of the exporters, to increase productivity, and to develop easier and speedier decision-making processes by means of the meetings to be held by exporters' associations and Turkish Exporters Assembly via visual systems on electronic medium.
- The "Pandemic Management and Working Guideline" was updated by the Ministry of Health and the chapter "Measures to be taken for In-house Meetings with Fewer Participants" was included in the guideline.
- Minister of Family, Labour and Social Services Zehra Zümrüt Selçuk stated that the first normalization steps will be taken as of June 15 in public and private nursing homes and care centres for the disabled.

## JUNE 13

- The Ministry of Interior sent a circular to the governorates of 81 provinces concerning the "Measures to be Implemented in Wedding Ceremonies".
- The Ministry of Education sent letters to the provincial directorates regarding additional measures to be taken at motor vehicle drivers courses, construction equipment operator courses, seafarer training courses, and pilot training courses.

## JUNE 15

- İstanbul Governorate announced that simultaneous inspections would be carried out throughout the city regarding compliance with the "new normal".
- Antibody tests were initiated in 81 cities with the "Community Screening Program" launched to combat the novel coronavirus.
- İstanbul Provincial General Hygiene Council banned acts such as demonstrations, open-air meetings, farewells, and tenting with more than 50 participants until the end of June as part of the measures against the novel coronavirus pandemic.
- 24 buildings were quarantined in Şanlıurfa as part of the measures against the novel coronavirus.

# Measures Taken

## JUNE 15

- As part of the novel coronavirus measures, going out to the streets without wearing a mask was prohibited in the city centre of Tunceli and its districts.
- Minister of National Education Ziya Selçuk stated that they had set up separate schools and locations, and the exam could be held at hospitals, if requested, in case there were children diagnosed with COVID-19 who would take the High School Entrance Exam (LGS) to be held on June 20.
- Turkish Airlines announced that it would operate a special flight on June 18 to return Turkish citizens who were stranded in Indonesia due to the coronavirus pandemic.

## JUNE 16

- Hearings and discoveries, which were suspended due to the COVID-19 pandemic, in the judicial and administrative first instance courts commenced again.
- The Ministry of Culture and Tourism announced that Turkish State Theaters, which had been closed for about 3 months as part of the fight against COVID-19, would resume the season with "Open-Air Theatre Plays for Summer" on July 2.
- Minister of Health Fahrettin Koca announced that it was forbidden to go out to the streets without wearing a mask in Diyarbakır, Erzurum, Kayseri, Rize, and Şanlıurfa.
- As part of the novel coronavirus measures, going out to the streets without wearing a mask was prohibited in the city centre of Tunceli and its districts.
- The Ministry of Health updated the guideline on the measures to be taken at wedding halls and venues.
- As part of the novel coronavirus measures, mask-wearing obligation was imposed throughout the province of Yalova.
- Turkish Consulate General in New York announced that Turkish Airlines would operate a special flight from New York to İstanbul on Wednesday, June 17.

## MEASURES TAKEN

## JUNE 17

- Following the Coronavirus Scientific Board Meeting, Minister of Health Fahrettin Koca stated that the Scientific Board suggested imposing mask-wearing obligations for İstanbul, Ankara, and Bursa.
- The Directorate General for Prisons and Detention Houses prepared a report titled "Penitentiary Institutions during the COVID-19 Pandemic" regarding the situation in prisons and the measures taken during the novel coronavirus pandemic.
- To inform the foreign public, Ombudsman Institution prepared a report entitled "Turkey's Fight against Coronavirus Disease" describing the health measures as well as administrative and economic measures taken during COVID-19.

## JUNE 18

- The Ministry of Interior announced that lockdowns would be imposed in 81 provinces on Saturday, June 20, at 09.00-15.00 when LGS would be held as well as on Sunday, June 28, at 09.30-15.00 when the Higher Education Institutions Examination (YKS) would be held.
- Ankara Governorate announced that wearing masks was made compulsory in the streets, avenues, outdoors, and indoors in Ankara.
- İstanbul Governorate announced that wearing masks was made compulsory in open spaces in İstanbul.
- It was reported that every day COVID-19 tests were performed on an average of 50 people selected by sampling method among those who entered Turkey through the border crossings in Edirne.
- Geçitli village of Bingöl's Karlıova district was quarantined. Entries to and exits from the village were prohibited.
- Turkish citizens in the USA returned home with a special flight from New York.

## JUNE 19

- The Ministry of Interior announced that the governorates were instructed to warn and inform those not complying with the obligation to wear a mask for 3 days, and to impose a fine of 900 TL on those who violated this rule as of Monday, June 22.
- According to the information from the Ministry of National Education, before the central examination within the scope of the High School Entrance Exam (LGS), the premises where the exams will take place have been cleaned in detail and the classrooms have been disinfected to ensure hygiene as part of the measures against Covid-19.
- In a statement by the Ministry of Interior, it was informed that general hygiene boards under the local authorities in provinces and districts put quarantine measures in place in 76 residential areas in total, including 2 towns, 28 villages, 40 neighbourhoods and 6 hamlets in 28 provinces.

## Measures Taken

### JUNE 20

- Minister of Family, Labour and Social Services Zehra Zümrüt Selçuk announced that elderly care establishments would not accept visitors on Father's Day due to the Covid-19 pandemic.
- It was announced that citizens in Samsun would be obliged to wear masks as part of the coronavirus measures.

### JUNE 21

- Two Turkish citizens diagnosed with the novel coronavirus in Russia were brought home with an air ambulance deployed by the Ministry of Health.
- The first chartered Turkish Airlines flight departing from the USA landed in İstanbul as part of the international flights resuming operations in phases following a period of suspension due to the novel coronavirus pandemic.
- Turkish Airlines' Sarajevo-İstanbul flights resumed following a 3-month suspension period due to the novel coronavirus pandemic.
- The Presidency of Red Crescent Academy conducted an online survey about the impact of Covid-19 on the society between April 16 and May 15 when the epidemic was experienced with all its dimensions.

### JUNE 22

- It was announced that citizens in Bilecik would be obliged to wear masks.
- The Centre for Assessment, Selection and Placement (ÖSYM) announced that the entrants of the Higher Education Institutions Examination (YKS) to be held on June 27-28 would be provided with mask and disinfectant as part of the coronavirus measures.

## MEASURES TAKEN

## JUNE 23

- The Ministry of National Education announced that counselling and educational assessment and diagnosis services at counselling and research centres would resume on July 6 and appointments at these centres would start to be given as of June 29.
- President of Religious Affairs Erbaş announced that mosques would be open as of June 24 for congregational prayer at all daily prayer times provided that mask-wearing and social distancing rules were observed.

## JUNE 24

- The Ministry of Culture and Tourism issued and distributed a circular titled "Controlled Normalization Process at Culture-Art Venues" to all 81 Provincial Directorates of Culture and Tourism, Turkish Hoteliers Federation, Turkish Hoteliers Union, Turkish Tourism Investors Association, and Cinema Hall Investors Foundation.
- The Ministry of Interior sent a circular titled "Measures to be Implemented in Wedding Ceremonies" to the governorates of 81 provinces.

## JUNE 25

- It was announced that a "pandemic team" would be set up in the Grand National Assembly of Turkey (GNAT) as part of measures against the novel coronavirus.
- The Ministry of Interior announced in a statement sent to the governorates of 81 provinces that citizens over 65 years of age would be able to travel for touristic purposes provided that they obtained a travel permit certificate.
- "Pandemic Management and Working Guideline" was updated and the chapter "Measures for Staff at Workplaces" was included.
- The Ministry of Family, Labour, and Social Services announced that face-to-face family counselling service would resume as of July 1, by observing the mask-wearing, social distancing, and hygiene rules.
- Turkish citizens in a mosque run by the Presidency of Religious Affairs of Turkey in the USA were tested for antibodies due to Covid-19.

# Measures Taken

**JUNE 26**

○ President Recep Tayyip Erdoğan held a video conference with students to take the Higher Education Institutions Examination. Erdoğan noted that all necessary measures were put in place for students to take the examination in a healthy and peaceful environment.

**JUNE 27**

- Twenty-three residences were quarantined as part of Covid-19 measures in Kayseri.
- A street was quarantined in Gebze, Kocaeli.

**JUNE 29**

- In his briefing after the Cabinet Meeting, President Recep Tayyip Erdoğan noted that
  - They did not err on the side of measures in the fight against coronavirus, and definitely did not make any concessions on cleanliness, mask, and distance principles, the initials of which are abbreviated as TAMAM, namely 'OKAY' in Turkish,
  - Turkey's healthcare infrastructure and the General Health Insurance System were unquestionably strong,
  - Service and production processes were back into operation in all sectors except few domains as part of the normalization calendar,
  - All segments in the economy, from tradesmen and craftsmen to farmers, and from industrialists to exporters, were provided with support,
  - All capabilities and resources of the state were put into use, including for financial aid, tax deferrals and loans.
- Fifty-five residences were quarantined in Şanlıurfa as part of measures against the novel coronavirus.
- It was announced that citizens in Çankırı would be obliged to wear masks as part of the coronavirus measures.

## MEASURES TAKEN



# Measures Taken

## JULY 2

- The Ministry of Culture and Tourism sent the amended "Circular on Controlled Normalisation Process at Accommodation Facilities" to the Ministry of Health, the 81 Provincial Directorates of Culture and Tourism, the General Directorate of Provincial Administrations, and the General Directorate of Local Administrations. An obligation to obtain a "Safe Tourism Certificate" was introduced for all accommodation facilities with a capacity of 50 rooms or more.
- It was announced that citizens in Bingöl would be obliged to wear masks as part of the Covid-19 measures.
- Ankara Provincial General Hygiene Board decided that all kinds of meetings, demonstration marches and similar activities be suspended for 15 days due to the recent increase in the confirmed cases.
- Some residential areas in three provinces were quarantined for 14 days as part of the fight against the novel coronavirus pandemic.
- Altınçevre Village, Hozat, Tunceli and Eskidemirkapı Village, Göle, Ardahan were quarantined for 14 days as part of the measures against the novel coronavirus.
- State Theatres, whose stage plays were suspended due to the novel coronavirus, were put back into operation with "Open Air Theatre Summer Plays".
- A Covid-19 test centre was set up at Trabzon Airport for passengers travelling abroad.

## JULY 3

- A Turkish couple diagnosed with Covid-19 in Saudi Arabia was brought home to Turkey via an air ambulance.

## MEASURES TAKEN

## JULY 4

- The Ministry of Interior sent a circular titled "Measures to be Taken at Amusement Parks and Thematic Parks" to the governorates of 81 provinces. It was decided that amusement parks and thematic parks, unless mobile, would start their operations as of July 6, provided that the rules set out in the circular were observed.
- Passengers from and to abroad started to be tested for Covid-19 at the Covid-19 laboratory set up at İzmir Adnan Menderes Airport by the Ministry of Health as part of the fight against the novel coronavirus.

## JULY 5

- Measures to be taken at schools to be opened as of August 31 were included in the "Covid-19 Pandemic Management and Working Guideline" prepared by the Ministry of Health Scientific Board.
- Minister of Foreign Affairs Çavuşoğlu stated that the greatest evacuation operation in the history of the Republic of Turkey was very successfully completed during the novel coronavirus period by bringing over 90 thousand citizens back home to Turkey from 130 countries.

## JULY 7

- The Ministry of Interior announced that a "Covid-19 Measures Check" would be conducted under the supervision and coordination of the governorates across Turkey on July 8, 2020.
- The Governorate of Ağrı announced, as part of the coronavirus measures, that citizens in the province would be obliged to wear masks, and all activities that contradict the measures against the pandemic, including farewell ceremonies and entertainment for newly recruited soldiers as well as relevant convoys and parades, were prohibited.

## Measures Taken

**JULY 8**

○ For the first time, a ban was imposed on the use of black masks, which the experts indicate to have no protective feature.

**JULY 9**

○ A three-story building in Kayseri and a village in Bingöl were quarantined.

**JULY 10**

○ The measures to be taken in markets and supermarkets in the "Pandemic Management and Working Guideline" were revised and updated by the Ministry of Health.

## MEASURES TAKEN

JULY 11

- Four Turkish citizens, who had been infected with Covid-19 in Kazakhstan and Azerbaijan, were brought to the country by an ambulance aircraft allocated by the Ministry of Health.
- It was stated that foreign holidaymakers aged 65 and over were exempted from the curfew in the Marmaris district of Muğla.
- Within the scope of measures against novel coronavirus in Şanlıurfa, quarantine was launched in 120 homes.

JULY 12

- Within the scope of measures against novel coronavirus, the Presidency of Religious Affairs released an informative video about postponing or cancelling pilgrimage visits for 2021.

JULY 13

- Within the scope of measures against novel coronavirus, wearing a mask was made compulsory for citizens in Kilis.

## Measures Taken

**JULY 14**

○ Turkish Football Federation's Professional Football Disciplinary Board (PFDK), fined the clubs, managers, coaches, and footballers for violating the social distance and mask rule within the scope of measures against novel coronavirus in the Super League games.

**JULY 15**

○ Four Turkish citizens infected with novel coronavirus in Kyrgyzstan were brought to the country by an ambulance aircraft allocated by the Ministry of Health.

**JULY 16**

○ It was reported that the centre set up to conduct novel coronavirus tests at Istanbul Airport served 1,500 passengers until now.

MEASURES TAKEN

**JULY 17**

- Two Turkish citizens infected with novel coronavirus in Kyrgyzstan were brought to the country by an ambulance aircraft allocated by the Ministry of Health.
- Within the scope of measures against novel coronavirus, it was stated that the soldier farewell ceremonies were restricted in Kırıkkale.

# Support Announced

The supports announced by Turkey to date in the context of the coronavirus pandemic are as follows:

2020

**MARCH 14**

• The hotline 184 of the Ministry of Health Communications Centre (SABİM) was established as the information line for coronavirus.

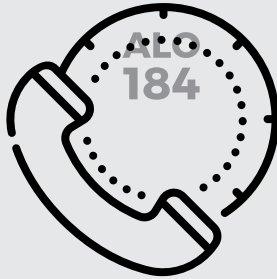

**MARCH 15**

• The Consulate Call Centre of the Ministry of Foreign Affairs was set up 24/7 for citizens abroad.



**MARCH 17**

• The follow-up period of the outstanding loans increased from 90 days to 180 days.

• The Central Bank announced that it would provide banks with all the liquidity they need within the framework of opportunities available in the day and overnight maturity.

• The assistance service was launched for patients and disabled taxpayers to submit statements from their address.

• The filing and payment period for the annual income tax returns to be filed by March 31 was extended to April 30, 2020.

SUPPORT ANNOUNCED



# Support Announced

**MARCH 18**

## **'Economic Stability Shield' Support Package**

- Within the scope of the "Economic Stability Shield" support package, President Recep Tayyip Erdoğan announced the following:
- Payments regarding SSI premiums, withholding tax returns and VAT returns for April, May and June shall be deferred by six months in various sectors including retail, malls, iron-steel, automotive, logistics-transport, cinema-theatre, accommodation, food and beverages, textile-apparel, event-organization.
- The accommodation tax shall not be applied until November.
- Easement fees and revenue share payments for hotel rentals for April, May, and June shall be deferred by six months.
- Credit principal and interest payments to the banks of firms whose cash flows deteriorated due to the measures taken against the Covid-19 pandemic shall be deferred by at least three months, and have additional financial support shall be provided if needed.
- Exporters shall be provided stock financing support in order to maintain the capacity utilization rates during the temporary slowdown in exports.
- Loan debts, principal and interest payments of artisans and craftsmen to Halkbank shall be deferred by three months in April, May, and June without interest.
- The limit of the Credit Guarantee Fund shall be increased from 25 billion Turkish Liras to 50 billion Turkish Liras. The firms and SMEs that require liquidity and have collateral deficit due to the negative impact of the recent developments shall be prioritized in the provision of commercial credits.
- The loanable amount for residential buildings with a price tag below 500,000 TL shall be increased from 80 percent to 90 percent with the minimum down payment reduced to 10 percent.
- The firms, which have fallen into default in paying their debts in April, May, and June due to the impact of Coronavirus, shall have a "force majeure" note in their credit registry.

## SUPPORT ANNOUNCED

- Minimum wage support shall continue.
- The lowest pension amount shall be increased to 1,500 TL.
- The holiday bonus of retirees shall be paid at the beginning of April.
- In order to ensure continuity in employment, the two-month compensatory working time shall be increased to four months.
- Periodic follow-up program consisting of social services and home-healthcare shall be introduced for seniors over 80 years of age and living alone.
- An additional fund of 2 billion TL shall be allocated as cash aid to families in need according to the criteria determined by the Ministry of Family, Labour, and Social Services.

In addition,

- With work to start in Istanbul and Ankara, protective masks and cologne shall be provided to all elderly people over the age of 65.
- Studies on developing a vaccine and medicine shall proceed at full pace.
- Turkish Airlines shall be provided with the required assistance.
- Preparations of questions for the High School Entrance Exam and the Higher Education Exam to be held in June will be made by taking the holiday periods into account.



# Support Announced

## MARCH 19

- Taxpayer groups were determined for the deferral of concise and VAT payments for six months.
- It was decided to increase the number of laboratories from 16 to 36 in a total of 25 provinces for the Covid-19 test.



## MARCH 20

- It was decided that private kindergartens and day-care centres that meet the conditions could benefit from the short work allowance.



## MARCH 21

- It was announced that within the framework of the Economic Stability Shield package, 2 million low-income families benefiting from social aid will receive 1,000 TL.
- It was decided that the Technopark management companies, incubator firms and commercial enterprises such as restaurants and cafes located in technoparks would not pay rent for two months.

## SUPPORT ANNOUNCED

## MARCH 22

- With the circular issued by the President Recep Tayyip Erdoğan, regulations enabling public personnel to work remotely entered into force.
- All execution proceedings for enforcement and bankruptcy, except for those concerning alimony payments, were suspended until April 30.
- It was announced that the Ministry of National Education increased the total number of Vocational and Technical Anatolian High Schools, which manufactured surgical masks, to 50 and aimed to raise the number of surgical masks produced monthly from 100 thousand to 2 million.

## MARCH 23

- It was determined that the cutbacks from municipalities amounting to 3 billion TL, would not be rendered for three months.
- The deadline for submission and payment of VAT returns was extended to April 24 and the deadline for submission of the Ba-Bs notification forms to April 30.
- It was announced that the additional payments of healthcare personnel would be ameliorated in three months and a total of 32 thousand healthcare professionals would be recruited.
- It was announced that for an effective diagnosis of Covid-19, 50 thousand additional rapid test kits were brought from China to Turkey.
- It was decided that the mass production of local ventilators would be initiated.

## MARCH 24

- Covid-19 medications brought from China were distributed to 40 provinces by air ambulances.
- It was decided that Halkbank would offer loans of 25,000 TL in cash with a six-month grace period and a 36-month maturity, and commercial cards (Tradesman Card) with a limit of 25,000 TL for all trades people without exception.
- Sectors and business lines falling into the scope of force majeure were identified for tax processes. Apart from these sectors, 1.9 million taxpayers who had income from commerce and agriculture or who were self-employed were included in the scope of force majeure.
- Payments regarding withholding tax returns and VAT returns for April, May, and June were deferred by six months. Withholding tax returns and VAT returns to be submitted in these months were postponed to July 27.
- It was decided to pay performance bonuses of employees in university hospitals from the salary cap for three months, and an additional 1.2 billion TL of funding was allocated within that framework.
- Tax returns and payments of taxpayers, who are unable to leave their homes for being older than 65 years of age or suffering from chronic illness, were postponed until the ban was lifted.

# Support Announced

## MARCH 25

The “omnibus bill” containing economic measures for many segments of the society was adopted at the Plenary Session of the GNAT.

Accordingly:

- The disabled and war veterans on pension who continue to work will now be entitled to obtain an old-age pension, provided they have at least 20 years of insurance and have paid 5,000 days of premium.
- Costs for the consumption of electricity and natural gas in disaster areas were delayed for up to one year.
- The Treasury and Finance Ministry's authority to transfer cash resources to credit guarantee institutions was increased to 50 billion TL.
- Employers from all sectors would receive a minimum wage subsidy of 2,50 TL per day and 75 TL per month this year without exception.

• Those who owe rent on the property of the General Directorate of Foundations were granted three months.

• The records kept by the Banks Association of Turkey Risk Centre of natural and legal persons who impede the payments of principal and/or instalment payments of loans used before March 24, 2020, shall not be taken into account by financial and credit institutions, provided that the payment for the overdue portion of these debts is paid in full or restructured as of December 31, 2020.

• With the amendment in the Cheque Law, the execution of sanctions of those, who have been convicted for committing the crime of issuing a bad cheque before March 24, 2020, shall be suspended.

• The inability to pay workplace rental from March 1, 2020, until June 30, 2020, shall not constitute a reason to terminate the agreement or to evict the tenant.

## SUPPORT ANNOUNCED

- The provision to fulfil the requirements to make an application for short-term work allowance, effective until June 30, 2020, shall be applied on condition that the workers must have been subject to a service agreement for 60 days prior to the date of commencement of the short-term work, and must have worked for 450 days with insurance and have had his/her unemployment insurance premium paid in the last three years, excluding the cases for the termination of the envisaged employment contract.
- With the minimization of the loss of workers' wages and the loss of labour in business, the two months applicable for compensatory work granted for employers was extended to four months.
- The minimum monthly payment, which is 1,000 TL for retirees and beneficiaries of old-age, invalidity, and death pensions, was increased to 1500 TL.
- The amount of the aid fund to be implemented by the employers' unions was increased from 25 percent to 35 percent.
- The Accommodation Tax effective date due to come into force on April 1, 2020, was postponed to January 1, 2021.
- All payments to be collected in the period between April 1, 2020, and June 30, 2020, for the use of land allocated to the investors and managers certified by the Ministry of Culture and Tourism to build tourism facilities shall be postponed for six months without the need for an application.
- It was decided to postpone debts owed to Small and Medium Enterprises Development Organization (KOSGEB) for three months, to grant an additional four months for KOSGEB projects, and to provide up to 6 million TL for the production of protective medical supplies as part of the "triple protection package" aimed at protecting the SMEs.
- It was decided to provide support to underground mining businesses.
- Additional customs duty on the import of medical masks, ventilators, and ethyl alcohol was remitted.
- It was decided that the healthcare professionals could use public transport and public social facilities free of charge.

# Support Announced

## MARCH 26

- The housing instalments to be paid in April and May by citizens, who had purchased houses from the Housing Development Administration of Turkey (TOKİ) and Emlak Konut, were postponed.
- Citizens aged 65 and over and those with chronic illnesses began to receive their pensions at home.
- Ministry of Industry and Technology initiated work to produce ventilators.
- Ministry of Industry and Technology provided flexibility for the loan interest support applied in investment subsidies. It was announced that the companies that are unable to make payments in time would also be able to benefit from interest or profit share support when they make bank payments related to the epidemic later.
- Covid-19 Portal was launched by TÜBİTAK.
- TÜBİTAK announced that the products used in the diagnosis and treatment of Covid-19 would be supported as part of the "SME R&D Start-up Support Programme".
- TÜBİTAK announced that the application deadlines for all open programs such as projects, scholarships, competitions, etc. were extended.
- TÜBİTAK announced that additional capacity was provided for the Turkish Academic Network and Information Centre (ULAKNET)/ Internet access to universities and distance education services.

## MARCH 27

- It was decided that Turkish Sugar Refineries Corporation (TÜRKŞEKER) decided to pay 250 million TL in advance, the total of the advance payments due to be paid to approximately 40 thousand for farmers at the end of June, and the molasses payment amounts due before the Eid al-Fitr and Eid al-Adha.
- The Istanbul Governorate announced that it would provide food parcel aid to 50 thousand people over the age of 65.
- The Banks Association of Turkey announced that two credit loan packages were put into practice by the banking sector for corporate and commercial customers whose economies were adversely affected by the pandemic.
- Maximum interest rates for credit cards were lowered. The lower limit of the minimum amount of credit card payments was reduced from 30 percent to 20 percent of the debt.

## SUPPORT ANNOUNCED

## MARCH 29

- It was announced that the bonus payments for Eid al-Fitr of almost 12 million pensioners would be paid between April 7-11.
- The validity period for the expired reports of disabled citizens receiving disability salary and home care aid has been extended until the end of May.

## MARCH 30

- In his address to the nation, President Recep Tayyip Erdoğan announced substantial supports. Accordingly, the following was announced:
  - Current hospitals will be reinforced; new hospitals will be put into service.
  - Payment of rediscount loans will be extended for another 90 days, thus offering 50 billion TL to exporters.
  - The Credit Guarantee Fund limit will be increased to 50 thousand TL and its capacity will be expanded to 450 billion TL to meet the demand of 850 thousand loans.
  - Minimum wage support will be extended, retiree holiday bonuses will be paid early, and 1000 TL each will be provided to 2 million households registered in the social aid program.
  - With the additional support of 6 billion TL, the performance payments of healthcare workers will be made from the maximum wage.
  - In order to help those who have suffered as a result of the measures taken, the "National Solidarity Campaign" will be launched and President Recep Tayyip Erdoğan will support the campaign by donating seven of his monthly salaries.
  - Nationalist Movement Party leader Devlet Bahçeli and Parliament Speaker Mustafa Şentop will also participate in the National Solidarity Campaign by donating five of their monthly salaries.
  - It was announced that the Turkish Exporters' Assembly will also participate in the campaign by donating 15 million TL; Turkish Union of Chambers and Exchange Commodities by donating 10 million TL; and Istanbul Chamber of Commerce by donating 5 million TL.

# Support Announced

## MARCH 30

- The call for needs of 569,549 households was met by the "Vefa Social Support Groups" under the coordination of governorates and district governorates.
- Ministry of Family, Labour, and Social Services announced that all businesses that slowed down/stopped their operations due to Covid-19 would be able to apply for short work allowance.
- It was announced that the delivery of 1,000 TL aid to 2 million 111 households in need would begin on April 1.
- It is stated that payments to lawyers under the Code of Criminal Procedure will be made in full by April 6.
- It was announced that public banks introduced a new loan for individual customers with a monthly household income of 5 thousand TL and less. Individual customers were provided with a loan up to 10 thousand TL, with a six-month grace period and up to a 36-month maturity of equal monthly instalments.

## MARCH 31

- The Government has launched the "National Solidarity Campaign" to lead the support work for those in need.
- The production of the "Three Ply Surgical Mask with Nose Piece Automatic Ultrasonic Manufacturing Machine" was completed in Istanbul Küçükköy Vocational and Technical Anatolian High School.
- Central Bank of the Republic of Turkey (CBRT) introduced additional measures to reinforce the monetary transmission mechanism and support firms exporting goods and services to limit the economic and financial impacts of coronavirus.
- In order to reduce the negative effects of the coronavirus pandemic on the tourism sector, revenues from tourism facilities on public lands to be collected in April, May, and June were postponed for six months.

## SUPPORT ANNOUNCED

## APRIL 1

- It was decided that the university students who wish to do so, could suspend their enrolment at higher education institutions in the spring term and it was decided that this period would not be deducted from the maximum time to graduate.
- Delivery of cash aid amounting to 1,000 TL, announced on March 30, 2020, by the Minister of Family, Labour, and Social Services Selçuk, started for 2 million 111 households.
- The masks, overalls, and disinfectants produced in factories and sewing houses of the Ministry of National Defence were delivered by the military cargo plane of the Turkish Armed Forces (TSK) to Italy and Spain, which are among the countries most affected by the coronavirus pandemic in Europe.
- Minister of Treasury and Finance Berat Albayrak announced that substitute teachers and qualified instructors would continue to receive additional tuition fees during the fight against coronavirus as well.

## APRIL 2

- The Presidential Circular No. 2020/5 on the Effect of the COVID-19 Pandemic on Public Procurement Agreements was published. According to the Circular, in the contracts executed as a result of the tenders made within the scope of the Public Procurement Law, if it is determined that the contractor is both prevented from fulfilling its contractual obligations, and is not able to overcome the impediment, a time extension may be granted or the contract may be terminated.
- It was announced that the medical reports and prescriptions of chronically ill patients, which expired on or after January 1, 2020, were extended until further notice.
- Minister of Youth and Sports Mehmet Muharrem Kasapoğlu said that the dormitory fees would be refunded to 380 thousand students; and that they would not be charged in April, May, and June.
- Director of Communications Prof. Fahrettin Altun announced that 552,529,912 TL had been collected so far as part of the National Solidarity Campaign launched by President Recep Tayyip Erdoğan's call "We are Self-Sufficient, Turkey."

# Support Announced

## APRIL 3

It was announced that 1,060,728,478 TL had been collected so far as part of the “We are Self-Sufficient, Turkey,” campaign.

- Ministry of Transport and Infrastructure announced that motor vehicle owners unable to go through due vehicle inspection within three months were given a 45-day time for the procedure as from the end of such period.
- Energy Market Regulatory Authority announced that “Comparative Billing” was introduced for electricity and natural gas. It will be applied in settlements, which are under quarantine and meter readings have been suspended in accordance with an administrative decision and in cases where the officials reading the meters are unable to maintain their social distance, and it will be applied for three months based on averages of the same months in the last two years.

## APRIL 4

● The accommodation tax, which would be enforced on April 1, has been postponed to January 1, 2021.

## APRIL 5

- Upon the orders of President Recep Tayyip Erdoğan, online mask distribution to citizens was launched via [maske.PttAVM.com](https://maske.PttAVM.com) under the coordination of the Ministry of Health and Ministry of Transport and Infrastructure.
- Ministry of Family, Labour, and Social Services confirmed the introduction of 93 medications to the reimbursement list, four of which are for cancer and epilepsy and three are for Parkinson's.
- The number of local medicines covered and paid by the Social Security Institution reached 8,556.
- It was decided to leave food, feed, and water to the habitats of stray animals having difficulty finding food due to the coronavirus pandemic.
- It was announced that the roads of Başakşehir İkitelli City Hospital would be completed by the Ministry of Transport and Infrastructure until May 20.

## SUPPORT ANNOUNCED

## APRIL 6

○ Following the Cabinet meeting, President Recep Tayyip Erdoğan made a statement regarding the fight against coronavirus. In his statement, he made the following remarks;

- Two pandemic hospitals will be built within 45 days in Istanbul,
  - In order to support the economy in this period of fighting against coronavirus, bank loans of 136 thousand enterprises will be postponed for 3 months,
  - It was announced that the aid would be provided to 2 million 300 thousand families in need.
- It was announced that applications for free mask distribution would be received through e-Government Gateway, and the sale of masks was banned.

## APRIL 7

○ Eligible army houses and military guesthouses were opened to healthcare personnel as part of the fight against the coronavirus pandemic.

○ In order to ensure proper and efficient allocation of the loans provided under the Economic Stability Shield, Banking Regulation and Supervision Agency has warned and given recommendations by sending a notice to the banks.

○ In a statement to the press after a meeting of the Coronavirus Science Board held through the video-conferencing method, Minister of Health Koca announced that a new committee was formed under the title of Social Sciences Board to provide recommendations to facilitate the societal life.

## APRIL 8

○ Minister of Industry and Technology, Mustafa Varank announced that those who want to work on R&D projects, including vaccination and drug development coronavirus, can apply for the scholarship program under TÜBİTAK.

○ It was announced that the Energy Market Regulatory Authority (EMRA) would not issue invoices by analogy for closed businesses and that the procedure would be limited to certain locations and certain periods.

○ Minister of Treasury and Finance Berat Albayrak announced 2.3 million more low-income families would be provided with one thousand TL each and the citizens who had to take unpaid leave with financial support.

## Support Announced

### APRIL 9

- The SGK redefined "emergency situation" by altering the Healthcare Practices Declaration. With the amendment, diagnosis and treatments for coronavirus were added to the procedures that are not paid in hospitals. Additionally, the drugs used in the treatment of the virus were included in the payment list of SGK.
- It was decided that the distribution of free masks in Istanbul would be carried out through pharmacies.
- The first intubation cabin of Turkey produced in Bursa was used for the first time in Bursa City Hospital.
- In order to protect healthcare personnel, a "video laryngoscope device" was developed in cooperation with Sivas Cumhuriyet University and industry through local and national resources.
- YÖK decided to complete the applied courses in the field, which were missing due to the coronavirus pandemic, by universities through distance education or summer courses.
- Ministry of National Education launched a distance education program for the professional and individual development of teachers during the period when education was interrupted.
- Ministry of Commerce launched an on-site customs clearance practice in export for manufacturing importers.

### APRIL 10

- Ziraat Bank reported that 1.1 billion dollars of outsourcing were provided with the participation of 38 banks from 22 countries.
- It was announced that the idle agricultural lands belonging to the Treasury would be made available to farmers for exemplary cultivation. It was stated that at the first stage 9 million square meters of the field would be cultivated.
- Ministry of Health's decision of free mask distribution to the citizens between the ages of 20 and 65 was put into practice in Istanbul.

### APRIL 11

- Due to the ban, essential needs such as bread were met through security forces, Vefa social support groups, local governments, mukhtars, and bakeries.
- Ministry of Family, Labour, and Social Services increased the amount of social benefits paid to women. Conditional maternity benefit was increased to 100 TL, and the amount paid within the scope of the benefits program for women whose spouse deceased was increased to 325 TL.
- The Ministry of National Education announced that currently 10 million masks and 300 thousand face shields have been produced per month in vocational high schools.

## SUPPORT ANNOUNCED

## APRIL 12

- Public banks postponed businesses' credit loans of 20.5 billion TL, and also 795 thousand citizens' debts of 40.6 billion TL.
- It was announced that citizens who cannot benefit from short-time employment allowance or are on unpaid leave would receive 1,170 TL of monthly stipends for 3 months.
- Vefa Social Support Groups continued their visits regularly to provide the needs of citizens and to monitor their situation.

## APRIL 13

- It was announced that the first part of Başakşehir City Hospital, with a total of 2,862 beds, 456 of which were intensive care beds, would be opened on April 20 and the second part on May 15.
- It was decided to bring two new hospitals in Istanbul, one of them in Hadımköy with 100 beds and the other in Derince with 250 beds.
- The number of countries to which material supply provided reached 34 within the scope of the fight against coronavirus pandemic.
- Minister of Justice Gül stated that human activity decreased by 95% in courthouses and 85% in notary public offices and said that citizens in need could make e-applications to notaries.
- Minister of National Education Selçuk stated that the first of 30 videos on courses of Turkish, mathematics, and social studies prepared for inclusive students would be broadcast on TRT EBA TV on April 17.
- Chairman of the Banking Regulation and Supervision Agency Akben announced that the maturity and amount restrictions applied in banks' derivative transactions of abroad residents rearranged within the scope of the steps taken in order to reduce the effects of fluctuations in the markets and protect financial stability.

## APRIL 14

- In the new bag law proposal submitted to the GNAT, the following provisions were included; Employees not granted short-term employment allowance will receive unpaid leave stipend of 1,170 TL monthly, and the requirement of 60-day inspector's exploration on the applications for short-term employment allowance will be lifted.
- The bill submitted to the GNAT paved the way for Turkey Wealth Fund to become a partner in large companies having difficulties due to the pandemic.
- Ministry of Agriculture and Forestry announced that the second campaign of the fish consumption launched for a healthy diet against the Covid-19 pandemic would continue with Turkish salmon tomorrow.
- It was announced that the free mask distribution carried out through pharmacies in cooperation with the Ministry of Health and the Turkish Pharmacists' Association would start in Antalya this week, as well.
- Minister of National Education Ziya Selçuk announced that the work that they initiated to make 17 international accredited software certification programs already available for teachers, for high school students, too, was completed.

# Support Announced

## APRIL 15

- ◉ Minister of Treasury and Finance Berat Albayrak announced that within the scope of the economic measures taken against coronavirus, the resources in the amounts of 12.1 billion TL allocated for the basic needs of 2.1 million citizens; A total of 6 billion 737 million TL to the tradesman with the Paraf Kart; 36 billion 326 million TL to industrialists with the support of İş'e Devam (Continue to Business).
- ◉ Minister of Energy and Natural Resources Fatih Dönmez introduced BOREL, domestic and national disinfectant.
- ◉ Istanbul Chamber of Pharmacists (İEO) announced that it has tripled the number of "pharmacies on duty" on Saturday, April 18, 2020, and for all Saturdays when the curfew may be imposed during the period.
- ◉ The local start-up company operating in the Informatics Valley in Kocaeli produced a device that provides breathing with sterile air to reduce the infection risk to the healthcare personnel.
- ◉ A company operating in ITU ARI Technopolis managed to produce masks of N95 and of higher quality, out of 100% domestic materials.
- ◉ A company operating in Gaziantep started to produce cabins of "biological sampling and intubation" that prevent healthcare personnel from getting into contact with patients.

## APRIL 16

- ◉ In the National Solidarity Campaign launched with the slogan "We are Self-Sufficient, Turkey" under the leadership of President Recep Tayyip Erdoğan, 1 billion 689 million 101 thousand 146 TL of donations were collected.
- ◉ In the wake of R&D works carried out by the Ministry of National Education, the first ventilator produced at Şehit Serkan Talan Vocational and Technical Anatolian High School in Hatay was introduced.
- ◉ Minister of Family, Labour, and Social Services Zehra Zümrüt Selçuk announced that the care costs of the elderly and disabled people in private nursing homes and disabled care centres have been met by the Ministry.
- ◉ Minister of Family, Labour and Social Services Zehra Zümrüt Selçuk announced that the stipend of 1,177 TL has been provided to workers who had to take unpaid leave after March 15 and who could not benefit from the Short-Term Employment Allowance.
- ◉ Ministry of Industry and Technology announced that the annual enterprise registers, which industrialists have to fill by the end of April each year, would be extended up to 4 months upon application.

## SUPPORT ANNOUNCED

## APRIL 17

- The mobile application "Mental Health Support System" (RUHSAD) was launched by the Ministry of Health for healthcare personnel working for the fight against Covid-19.

- It was announced that under the coordination of the Malatya Metropolitan Municipality, 12 textile factories in the city produced 2 million masks per day.

- Minister of Health Fahrettin Koca announced that for those who have not received a message for the free mask, a new code would be given again when they apply to the pharmacy.

- Ministry of Family, Labour, and Social Services announced that an additional 2 periodic shares of 352 million 880 thousand 238 TL would be sent to the Social Assistance and Solidarity Foundations.

- The issuance and payment deadlines of corporate tax returns, which must be submitted by April 30, was extended to the end of the day on June 1.

- Istanbul Governor Ali Yerlikaya announced that PTT has delivered 500 thousand masks to people, mask production has started in 17 high schools and 926 thousand packages sent by the Presidency have been delivered to citizens. In addition, it was declared that the healthcare personnel has been provided with the support of 5,720 rooms and transportation.

- In Istanbul Kartal Şehit Öğretmen Hüseyin Ağırman Vocational High School, the remote-controlled ventilator was produced for ambulances and field hospitals.

- Minister of National Defence Hulusi Akar announced that a mechanical ventilator has been produced by the Machinery and Chemical Industry Institution through domestic and national resources. He announced that the aim was to manufacture 500 mechanical ventilators per week by initiating mass production as soon as possible.

- The CBRT announced that the maximum limit for the ratio of the Open Market Operations portfolio nominal size to the CBRT analytical balance sheet total assets, set at 5% for 2020, has been revised to 10%.

## Support Announced

### APRIL 18

- Ministry of Health launched the "Hayat Eve Sığar" mobile application, sharing the risk information, follow-up family members, Covid-19 test, daily coronavirus table, and the information on the hospitals and pharmacies on the map.
- In Ankara, in order to shorten the time to reach the hospital where healthcare personnel work, bus routes and stop numbers were rearranged.
- Through his project, Turkish scientist Mert Gür modelled the "activation mechanism" of the protein, which enables the coronavirus to bind to human cells, with molecular dynamics simulations.

### APRIL 19

- Minister of Family, Labour, and Social Services Zehra Zümrüt Selçuk noted that within the scope of the Economic Stability Shield Package, 1,000 TL aid in cash to 2 million 300 thousand families initiated.
- TÜBİTAK announced that up to 200 thousand TL of resources would be granted to the projects that examine the effects of coronavirus in terms of social and human sciences and develop solutions.
- Chairman of the Banking Regulation and Supervision Agency Mehmet Ali Akben announced that a new regulation has been made to enable banks to use their resources more efficiently and to focus on credit distribution having principal intended action.
- CBRT Governor Murat Uysal announced that a series of meetings have been held via video conferencing to strengthen the existing cooperation with the central banks of various countries and establish new swap agreements, considering the effects of the coronavirus pandemic on the global and national economy.
- Minister of Culture and Tourism Mehmet Nuri Ersoy announced that the Turkey Tourism Promotion and Development Agency would launch an intensified promotional campaign as of mid-May. In this context, low-interest loans up to 10 thousand TL with a 6-month non-payment period and 36-month maturity have been made available for professional tourist guides, by starting to receive applications through the Ministry's website.

## SUPPORT ANNOUNCED

## APRIL 20

● YÖK President Prof. Yekta Saraç stated that it was important for the academics and students, who are abroad and who want to return to Turkey, to contact relevant embassies/consulates and to follow the official web page and social media accounts of the Ministry Foreign Affairs.

● The evacuation of approximately 25 thousand Turkish citizens, who are locked-down in their countries due to the travel ban, imposed under the coronavirus measures, started. The first evacuation group was brought in Turkey from Frankfurt, Germany.

● President Erdoğan made a statement regarding the support to be made after the Cabinet meeting;

- Free mask distribution continues through PTT and pharmacies,
- Through the cooperation with Turkish Airlines, 39 thousand citizens have been brought to the country so far and the aim is to complete these operations until Ramadan,
- Live course practice started for the 8th and 12th-grade students who are preparing for secondary and higher education exams,

■ Within the scope of the project launched by the Ministry of Treasury and Finance, trainings will be carried out through the BTK academy training program, 31 different training services are provided on this site, and the number of trainings will increase to 100 by the end of the year,

■ In order to support and encourage agricultural production, rent payments for April, May, June of the farmers renting the Treasury-owned land for agricultural purposes are postponed for 6 months and that 14 million square meters of Treasury land, especially in Erzincan, Erzurum, Kars, Kayseri, Sivas, Bingöl, and Muş provinces have been made available to the use of farmers,

■ Cash aid was granted to 2 million 100 thousand families without any income and 2 million 300 thousand families applied for aid in cash of 1,000 million TL in the second stage,

■ More than 500 million TL of additional aid has been provided to social assistance and solidarity foundations in Ramadan, in 81 provinces 2 million 234 thousand students have been provided with conditional education aid as of 75 TL for girls and 50 TL for boys, and 150 TL for 41 thousand orphaned students per month.

# Support Announced

APRIL 21

- Applications for the third phase of the Social Aid Program initiated through the e-Government app.
- It was announced that the delivery of masks to the relevant institutions charged with the distribution would be conducted by the State Materials Office (DMO).
- Minister of Family, Labour, and Social Services, Zehra Zümrüt Selçuk announced that the monthly aid amount delivered under the Needy Soldier Family Assistance Program was increased from 275 to 400 TL with an increase of 45.45 percent.

APRIL 22

- SABİM 184 WhatsApp Hotline was established to serve the fight against coronavirus.
- Applications for the Cash Aid practice started for workers on unpaid leave.
- UVC Air Sterilization Device was produced by Istanbul Arnavutköy İbrahim Özyaydın Vocational and Technical Anatolian High School.
- Kağıthane Gültepe Vocational and Technical Anatolian High School started mass production of face shields by developing the mould.

APRIL 23

- In 2/B and agricultural land sales, 46 thousand 500 beneficiaries' payments for April, May, and June were postponed for 3 months without occurring any raise or interest and without an application requirement.
- Unemployment benefits of May began to be deposited into bank accounts.
- It was decided that TÜRKŞEKER would pay the seed, fertilizer and cash advance of the crops to be raised following the beet.
- One million 160 thousand 807 citizens aged 65 and over who are on lockdown within the scope of the measures against Covid-19 were provided with cologne and masks in Istanbul.

APRIL 24

- The final stage was reached in the transition to mass production of the domestic ventilator "Sahara."
- Within the scope of the measures against coronavirus, it was announced that "1-GB internet" would be granted to every citizen by all GSM operators.
- Ministry of Family, Labour, and Social Services allocated 176 million TL for food aid to those in need during Ramadan as part of the measures against coronavirus.
- Ministry of National Defence reached the production of 10 million masks per week, as a result of intensive work on the fight against Covid-19.

## SUPPORT ANNOUNCED

## APRIL 25

- Total amount of steps taken under the Economic Stability Shield increased up to 200 billion TL and the number of families receiving financial support of 1,000 TL reached 4.4 million.
- Applications started to be received through e-government for the aid of 1,000 TL to the citizens not covered by financial support but lost their income during the coronavirus pandemic period.
- Since the transformation projects could not be completed for various reasons, housing benefits for those who could not get their houses were extended from 36 months to 48 months.
- Ministry of Commerce launched a solidarity campaign with the theme "We are with SMEs as E-Commerce" to support SMEs in the field of electronic commerce.
- After the meeting held by sector representatives to make tourism in Turkey to be revitalized rapidly after the coronavirus pandemic, a roadmap was created. In the first place, it was decided for the hotels to serve with half capacity and for the beaches to comply with the social distancing rule.

## APRIL 26

- Within the framework of the support for the sectors affected by the coronavirus pandemic, the scope of the fields of activity and the occupational groups, of which premium payments were postponed, were announced.

## APRIL 27

- In Istanbul, vocational high school teachers developed an air disinfection device and contactless thermometer and created their software and hardware as well.

## APRIL 28

- In order to prevent the contact of healthcare personnel with suspicious cases and to create a protective zone in the diagnosis and confirmation stages of Covid-19, one hundred percent domestic sampling cabin was developed.
- "Sampling Cabin" produced in Ankara Chamber of Industry, 1st Organized Industrial Zone, started to be used in Ankara Dr. Nafiz Körez Sincan State Hospital.

# Support Announced

**APRIL 30**

- The Ministry of Agriculture and Forestry introduced the Digital Agricultural Market (DİTAP) project aimed at bringing together both the producers and consumers online.
- Halkbank launched the “Lifeline Loan for Business Continuation Assistance and Small Businesses” with a total of 36-month maturity without principal and interest-fee payments for 6 months.
- “COVID-19 Shared Mind Platform of Turkey”, which was created on the internet by around 50 universities, institutions, and non-governmental organizations, started its activities.
- PTT announced that the daily free withdrawal limit from the ATMs had been increased from 3 thousand TL to 5 thousand TL.
- It was proposed to establish a “green corridor” among Turkic Republics for the transportation of foodstuffs, medical supplies, and other basic goods to alleviate the effects of the COVID-19 pandemic and to create a “task force” aimed at coordinating transportation and logistics.

**MAY 1**

- Turkish Pharmacists' Association (TEB) indicated that nearly 55 million masks had been dispatched to pharmacies in Turkey and nearly 40 million masks were distributed to citizens by the pharmacies.

**MAY 2**

- The Ministry of Industry and Technology announced that approximately 250 million masks were distributed to citizens and healthcare professionals free of charge during the pandemic.

**MAY 3**

- Portable mechanical ventilators were manufactured at Ereğli Science and Arts Centre in Zonguldak for patients with respiratory problems.

## SUPPORT ANNOUNCED

## MAY 4

- President Recep Tayyip Erdoğan stated that the construction of two hospitals with a total capacity of 2 thousand beds in Yeşilköy and Sancaktepe continued rapidly and that the projects would be completed in a short time and two important permanent hospitals would be provided for Istanbul.
- The Ministry of Health stated that with the mobile application “Life is at Home” a free mask code can be obtained as part of the fight against coronavirus.

## MAY 5

- It was announced that Vefa Social Support Groups had met 4 million 541 thousand 829 requests out of 4 million 924 thousand 927 received since March 22.
- It was announced that breeders would be provided with feed support of 65 TL per animal, making a total support package of 100 million TL.

## MAY 6

- It was announced that 32 more drugs used in the treatment of many diseases such as COVID-19, cancer, and Parkinson’s were included in the drug reimbursement list.
- Minister of Industry and Technology Mustafa Varank announced that 300 trainees out of 340 applicants were found eligible to participate in the Intern Researcher Scholarship Program, which was announced to encourage the COVID-19 projects.
- It was announced that a systemic antiviral drug with the active substance “oseltamivir”, used for the treatment protocol of COVID-19 disease, was included in the drug reimbursement list.

## Support Announced

**MAY 7**

- As part of the third-phase social welfare program, payments were made to 620 thousand households.
- Surgical masks would be put up for sale, each to be sold for a maximum price of 1 TL.

**MAY 8**

- Within the framework of the law enacted on April 17, it was stated that the government started to pay a daily cash support payment of 39.24 TL, which makes a monthly payment of 1,177 TL, to those who were on unpaid leave due to the coronavirus and who could not receive unemployment benefits.
- Minister of Family, Labour, and Social Services Zehra Zümrüt Selçuk stated that 32 more drugs used in the treatment of many diseases such as COVID-19, cancer, and Parkinson's were included in the drug reimbursement list, and pension payments would be made between 15-22 May.

**MAY 9**

- A medicine was produced by a local pharmaceutical company for the treatment of COVID-19. The authorization of sale was granted for the drug, which was licensed by the Ministry of Health Turkish Medicine and Medical Devices Agency with high priority.
- Minister of Youth and Sports, Mehmet Kasapoğlu, indicated that the youth centres under the Ministry had so far produced and distributed 850 thousand masks as part of the fight against coronavirus.
- Mechanical and Chemical Industry Company (MKEK) developed a local surgical mask production machine and commenced the production of machines.

**MAY 10**

- President Recep Tayyip Erdoğan made examinations at the hospitals under construction in Sancaktepe and Atatürk Airport as part of the fight against the COVID-19 pandemic.

## SUPPORT ANNOUNCED

## MAY 11

- Turkish Radio and Television Corporation (TRT) announced that young people posting the best social media sports videos recorded at home with the hashtag #May19atHome would have the chance to meet Turkey's 19 leading athletes.
- Minister of Transport and Infrastructure Adil Karaismailoğlu announced that the access roads constructed for Başakşehir İkitelli City Hospital would be completed by May 20, the same day when the hospital will be put into service.

## MAY 13

- Minister of Treasury and Finance Berat Albayrak announced that the financial amount of the "Economic Stability Shield" package reached 240 billion TL.
- Minister of Industry and Technology Mustafa Varank stated that there were 17 vaccine-drug development projects underway and that scholarship was offered to 300 interns working in these projects.
- A touchless hand disinfectant device prototype was developed by vocational high school teachers in Bursa for use during the coronavirus pandemic period, particularly in examination halls.
- Minister of Industry and Technology Mustafa Varank stated that an innovative kit, alternative to the PCR method used for the early diagnosis of coronavirus, had been developed and announced that the prototype would be completed in June.
- Minister of Trade Ruhsar Pekcan announced that there would be no pre-authorization requirements for the export of re-usable cloth masks.

## MAY 14

- The Ministry of Interior announced that the Vefa Social Support Groups reached out to 5 million 674 thousand 281 households in 53 days.
- The Disaster and Emergency Management Presidency (AFAD) announced that a total of 71 million 294 thousand 214 TL had been spent during the fight against coronavirus.

## Support Announced

**MAY 15**

- Minister of Agriculture and Forestry Bekir Pakdemirli said that the isolated virus would be administered to animals next week as part of the antiserum studies conducted by the Ministry in the fight against coronavirus.
- Minister of National Education Ziya Selçuk announced that 20 million masks had been produced by maturation institutes in one month.
- A vocational high school in Hatay developed N95 and surgical mask machine.

**MAY 16**

- It was announced that patients from 31 countries would be admitted as of May 20 within the framework of health tourism during the controlled normalization process of the novel coronavirus pandemic.

**MAY 17**

- Military Electronics Industries (ASELSAN) and Bilkent National Magnetic Resonance Research Centre (UMRAM) developed the prototype of the first domestic MR device under the coordination of the Presidency of the Defence Industries of the Republic of Turkey.
- While work on domestic ventilators, cardiopulmonary pumps, mobile X-ray machines, portable defibrillators continue, R&D studies are underway on patient care, diagnostic kits, data, and image processing.
- The Ministry of National Defence (MSB) announced that, as part of the novel coronavirus measures, they continued to provide food supplies to the families and relatives of our martyrs and veterans who were over 65 years of age and who were unable to leave the house during Ramadan and to those in need.
- It was announced that the domestic drug, which is ready for distribution for the treatment of novel coronavirus, will first be used in patients in Turkey and will be distributed to world markets in the event of an export license being issued.
- The Ministry of Industry and Technology announced that the deadlines for R&D and design centre activity reports and corporate financial audit reports of Technology Development Zones (TDZs) were extended until 30 June 2020.

## SUPPORT ANNOUNCED

MAY 18

- Mass production of N95 masks began at Tekirdağ Çerkezköy Turkish Textile Foundation Vocational and Technical Anatolian High School.
- Erzurum City Hospital was put into service.

MAY 20

- Minister of Treasury and Finance Berat Albayrak announced that the sum of relief provided reached 252 billion TL, and with the inclusion of deferred loans and interest payments, it exceeded 350 billion TL.

MAY 21

- Following the ceremony attended by President Recep Tayyip Erdoğan, Başakşehir Çam and Sakura City Hospital, built as part of the "Transformation in Healthcare" project and the first phase of which was put into service on April 20, began serving with full capacity.
- During his speech at the inauguration ceremony of Başakşehir Çam and Sakura City Hospital, President Recep Tayyip Erdoğan emphasized that the hospital had an 8,134-vehicle car park and 3 helipads, that it would also provide services for non-Turkish patients, and turn Istanbul into an international hub of healthcare.
- International students, who were unable to return to their countries due to the COVID-19 pandemic, both practice and make a living by working in fields and gardens where Niğde Ömer Halisdemir University is cultivating for research and practice.
- The Ministry of Family, Labour, and Social Services announced that the disabled people and their families staying home during the period of the fight against coronavirus would be provided with distance education support in cooperation with TRT.

MAY 22

- Minister of Trade Ruhsar Pekcan announced that they had launched the "Stock Financing Support Package" of Turkey's Eximbank in order to reduce the negative effects of the COVID-19 pandemic on exporters.
- Minister of Family, Labour, and Social Services Zehra Zümrüt Selçuk stated that the additional payments of public workers, worth of 13 daily wages, would be deposited in their accounts before the Eid al-Fitr holiday.

# Support Announced

## MAY 23

- Minister of Treasury and Finance Berat Albayrak announced that the sum of relief provided through the Economic Stability Shield Package reached 252 billion TL, and added;
  - Nearly 5.5 million families received 1000 TL of cash support,
  - Approximately 66 billion TL of tax statements and payments for SSI and BAĞ-KUR were deferred,
  - For nearly 4 million workers short-term work allowance support was given to companies,
  - More than 6 million citizens with an income of less than 5 thousand TL received support worth 37 billion TL for individual needs.
  - Nearly 25 billion TL of financial support was provided to 1.1 million tradesmen,
  - 180 thousand 933 companies received 145.6 billion TL of support to continue their activities.
- Prof. Sedat Yıldız, Faculty Member at the Department of Physiology of İnönü University Faculty of Medicine, stated that the ELISA test for COVID-19 diagnosis had been developed.
- Conducting a thermal imaging test to be used in its current products, MKEK developed a thermal camera system to measure body temperatures in crowded places during the fight against the COVID-19 pandemic.
- The Ministry of National Education announced that the face shields manufactured by 154 Science and Arts Centres were delivered to the General Directorate of Prisons and Detention Houses.

## MAY 24

- In his message on the occasion of the Eid al-Fitr, President Recep Tayyip Erdoğan stated the following:
  - Pointing out that many areas, from economy to social life, were seriously affected by the measures implemented as part of the fight against the pandemic, he stated that although they experienced difficulties in March and April, they, together with other countries, had started to gradually take steps for normalization in May.
  - He stated that, through Social Protection Shield programs, support was provided to both their citizens in need as well as their workers, who fell into difficulty due to the loss of employment and in this regard, with

## SUPPORT ANNOUNCED

MAY 27

the understanding of “keep people alive so that the state will live”, they conducted an unrequited transfer of nearly 12 billion liras worth of fund to approximately 10 million citizens.

- He noted that during the pandemic process, they had put all the state means, such as tax, premium and instalment postponements as well as financial facilities, at their people's disposal.

- Minister of Family, Labour and Social Services Zehra Zümür Selçuk indicated that, as part of the national solidarity campaign called “We Are Self-Sufficient Turkey” launched on March 30 in order to support the citizens in need during the fight against COVID-19, a total of 2 billion 30 million 380 thousand 771 TL was raised, while the citizens sent 6 million 405 thousand 225 SMS for the campaign to date.

- Turkish Red Crescent started manufacturing masks again at the mask factory, which it established in 1935 and transferred eight years later to the Ministry of National Defence.

- Minister of Treasury and Finance Berat Albayrak commented on the Turkish Economy in 2020, financial package introduced during the coronavirus pandemic, and the new support packages to be introduced. In this regard, he expressed the following:

- Turkey would be the country least affected by COVID-19 and shows positive signals for improvement in many areas ranging from growth to unemployment when compared to the whole world,

- Despite the crisis, great efforts were exerted in order to end this year with a positive growth rate instead of 5, 8, or 10 percent shrinkage,

- The financial package is a significant package exceeding 260 billion TL and close to 600 billion with the multiplier effect, that constitutes 5 percent of the national gross product with the impact of 260 billion TL, and 10-11 percent of the national gross product with the multiplier effect,

- More than 200 thousand companies applied to the Continue to Business Loan, more than 180 thousand companies were granted this loan and the loans provided amounted to 150 billion TL,

- Nearly 7 million individual consumer loans were provided and more than 85 percent of applications were approved,

- As part of the normalization process, rapid steps for the continuation of the economic activity would be taken and for the normalization of the domestic market, domestic demand, social aid support packages, and financial loan support packages would be introduced.

# Support Announced

MAY 28

- Upon the instructions of President Recep Tayyip Erdoğan, Presidential Science, Technology and Innovative Policies Council launched efforts to determine Turkey's inadequacies and develop necessary technologies in the fields of "food supply security", "biosafety", "cybersecurity and communication infrastructure", "medical devices" and "drug and vaccine".
- Minister of Trade Ruhsar Pekcan indicated that companies' membership to e-trade sites, virtual trade delegations and their participation in virtual fairs, and the organization of virtual fairs were included within the scope of support.

MAY 29

- It was noted that, as part of the study conducted by Istanbul Medeniyet University, coronavirus samples, which were taken from four patients and isolated, were sequenced, and their genetic maps were constructed.
- Constructed in Sancaktepe, Istanbul, Prof. Feriha Öz Emergency Hospital was completed within 45 days and was inaugurated with a ceremony attended by President Recep Tayyip Erdoğan. It was stated that the hospital would also serve in the field of health tourism.

MAY 31

- Yeşilköy Prof. Murat Dilmener Emergency Hospital and Hadımköy Dr. İsmail Niyazi Kurtulmuş Hospital, the construction of the former and the restoration of the latter were completed as part of the fight against the pandemic, were inaugurated with a ceremony attended by President Recep Tayyip Erdoğan. The hospitals that will play an important role during the COVID-19 pandemic will also serve foreign patients as part of health tourism.
- It was announced that healthcare professionals could use Marmaray and Başkentray free of charge for 3 more months.

JUNE 1

- Public banks introduced four exclusive funding packages to support domestic production, ensure recovery in all sectors, and boost social life by meeting the needs of citizens in the period of normalization.
- The incentive that allows healthcare professionals to make use of guesthouses and public social facilities used for accommodation purposes was extended until August 31.

## SUPPORT ANNOUNCED

## JUNE 2

○ To eliminate the negative effects of the pandemic, public banks decided to provide housing loans with the lowest interest rate in the history of Turkey by 0.64 percent to the citizens.

## JUNE 3

○ Vice President Fuat Oktay attended the Turkish Industry and Business Association (TUSIAD)'s meeting themed "Business World During and After COVID-19" via video-conference.

○ Minister of Treasury and Finance Berat Albayrak held a meeting with the general managers of some banks to discuss the situation of the banking sector and mutual expectations regarding the COVID-19 pandemic period and the normalization process.

## JUNE 4

○ Minister of Treasury and Finance Berat Albayrak announced that they provided farmers with advance support of over 400 million TL for grain production and beet pulp during the COVID-19 pandemic.

○ The Ministry of Health's Vaccination Science Board of the Turkish National Institutes of Health held a meeting with Russian scientists regarding cooperation on COVID-19 vaccine development via video conference.

## JUNE 5

○ The Central Bank of the Republic of Turkey announced that a 20 billion TL investment incentive loan would be granted to companies in certain sectors that have an investment incentive certificate.

○ Minister of Treasury and Finance Berat Albayrak stated the following:

- Preparations for a package began under the name of a broad employment shield in an atmosphere in which dollarization was reversed,
- 150 billion TL was provided to support the small and medium-sized enterprises (SMEs) in 1.5 months,
- Central Bank was carrying out intensive technical work on swap regulations,
- The demand for housing loans within the new economic packages of public banks exceeded 15 thousand.

## Support Announced

**JUNE 6**

General Director of Agricultural Credit Cooperatives of Turkey stated that the interest of fixed-rate loan on agricultural inputs was lowered from 5.5 percent to 4.5 percent.

**JUNE 8**

Minister of Family, Labour and Social Services Zehra Zümrüt Selçuk announced that Cash Support Payments for May started.

Minister of Treasury and Finance Berat Albayrak announced that companies would be provided investment support of up to 400 million TL with a maximum maturity of 10 years through the "Single Credit for Investments".

Ege University Hospital's scientific team announced they had developed a tomography software to diagnose, determine the stage and spread of COVID-19, as well as to measure its damage to the lungs.

**JUNE 12**

The domestic synthesis of the drug named Favipiravir, which was announced by President Recep Tayyip Erdoğan and developed by the scientists under the umbrella of the Scientific and Technological Research Council of Turkey (TUBITAK) COVID-19 Platform, was promoted. The first sample of the locally synthesized drug, which is at the stage of licensing, was presented to the Minister of Industry and Technology Mustafa Varank.

Presidency's Directorate of Communications sent support packages containing protective equipment and hygiene supplies to members of the press, who have made a significant contribution to providing prompt and accurate information to the public by making great sacrifices during the fight against the Covid-19 pandemic.

Concerning the minimum/maximum tariff of fares to be imposed in the field of highway passenger transport, the Ministry of Transport and Infrastructure revised the maximum tariff of fares set on May 14 and reduced the maximum tariffs between 25 to 30 percent.

## SUPPORT ANNOUNCED

JUNE 13

○ Minister of Family, Labour and Social Services Zehra Zümrüt Selçuk stated the following:

- The termination of employment constraint had been extended to protect both the employment and the employer, while “additional employment support” will be provided to the employers who extend additional employment support,
- “Normalization support” would be provided for employees, who apply for short-term work allowance and who benefited from an unpaid leave of absence support, to enable them to get back to normal working life,
- The number of employees receiving cash support payments reached 1 million 358 thousand,
- 1 billion 700 million TL of financial aid was given to the employees.

JUNE 14

○ A vocational high school affiliated to the Ministry of National Education broke new ground by exporting the surgical mask it produced as part of the fight against the coronavirus.

○ Technopark Istanbul's incubation centre, Cube Incubation, was entitled to receive support with the "Entrepreneurship Ecosystem Renewal Project: Regeneration-20" as part of the Istanbul Development Agency's Struggle and Resilience Program against COVID-19.

JUNE 17

○ Minister of Family, Labour and Social Services Zehra Zümrüt Selçuk announced that the "Social Protection Shield" provided approximately 20.5 billion TL of cash support.

JUNE 18

○ Minister of Family Labour and Social Services Zehra Zümrüt Selçuk stated that they were monitoring young people, who have grown up under state protection and have left the institution, more closely during the fight against Covid-19 and were supporting their employment by providing financial assistance.

## Support Announced

**JUNE 20**

• During the 'ReTurkey' (Re-Discover) event organized for the coronavirus measures and the start of the tourism season, Minister of Culture and Tourism Mehmet Nuri Ersoy noted that the cost increases due to the coronavirus would not be reflected on the prices, and added that the aim of the hotels was not to raise prices but to re-open facilities.

**JUNE 25**

• The Social Sciences Board of the Ministry of Health stated that the social, psychological, and economic effects of coronavirus would be monitored and an initiative would be taken to propose solutions.

**JUNE 27**

• It was stated that public officials travelling abroad on duty would not pay the test fee.

**JUNE 30**

• Minister of Family, Labour and Social Services Zehra Zümürüt Selçuk stated that the amount of assistance and support provided by the Ministry reached 24 billion TL, 6 billion TL had been delivered to more than 6 million households, with 1,000 TL per household, as part of the "Pandemic Social Support Program".

• The Executive Order on extending the short-term work allowance for workplaces, which introduced short-term work due to the coronavirus, was published in the Official Gazette.

SUPPORT ANNOUNCED

**JULY 3**

● President of the Council of Higher Education (YÖK) Prof. Yekta Saraç stated that the first virtual fair on a global scale in the history of higher education would be held on July 20-22 to reduce the negative effects of student mobility restricted during the coronavirus pandemic and also to promote the Turkish universities in foreign countries through digital channels.

**JULY 4**

● President Recep Tayyip Erdoğan stated that the duration of the short-term work allowance and cash support payments would be extended and they would continue to stand with the employees during the post-pandemic period.

## Support Announced

**JUNE 20**

• During the 'ReTurkey' (Re-Discover) event organized for the coronavirus measures and the start of the tourism season, Minister of Culture and Tourism Mehmet Nuri Ersoy noted that the cost increases due to the coronavirus would not be reflected on the prices, and added that the aim of the hotels was not to raise prices but to re-open facilities.

**JUNE 25**

• The Social Sciences Board of the Ministry of Health stated that the social, psychological, and economic effects of coronavirus would be monitored and an initiative would be taken to propose solutions.

**JUNE 27**

• It was stated that public officials travelling abroad on duty would not pay the test fee.

**JUNE 30**

• Minister of Family, Labour and Social Services Zehra Zümürüt Selçuk stated that the amount of assistance and support provided by the Ministry reached 24 billion TL, 6 billion TL had been delivered to more than 6 million households, with 1,000 TL per household, as part of the "Pandemic Social Support Program".

• The Executive Order on extending the short-term work allowance for workplaces, which introduced short-term work due to the coronavirus, was published in the Official Gazette.

SUPPORT ANNOUNCED

**JULY 3**

● President of the Council of Higher Education (YÖK) Prof. Yekta Saraç stated that the first virtual fair on a global scale in the history of higher education would be held on July 20-22 to reduce the negative effects of student mobility restricted during the coronavirus pandemic and also to promote the Turkish universities in foreign countries through digital channels.

**JULY 4**

● President Recep Tayyip Erdoğan stated that the duration of the short-term work allowance and cash support payments would be extended and they would continue to stand with the employees during the post-pandemic period.

**JULY 11**

● It was stated that one-time-only feed support would be provided to small-capacity livestock businesses that have difficulties in feed supply due to the novel coronavirus pandemic.



## **Fight against Covid-19 in Turkey: Effective Measures and Comprehensive Support**

**One of the priorities in terms of the national fight against coronavirus is to slow down the spread of the pandemic. The set of measures chronologically presented above shows that in line with the recommendations of Science Board, Turkey has taken all the necessary steps even before the first case confirmed in Turkey, to retard the entry of the pandemic to our country to the latest possible date, and upon entry to slow down its spread speed.**

With the measures taken, rising awareness activities have been carried out for the citizens on the golden rules for protection from the pandemic, voluntary quarantine practice, and personal hygiene, by using all communication channels by all relevant institutions of Turkey as well as preventing the spread of pandemic through social interaction.

One of the most important components of the national fight against coronavirus in Turkey is the healthcare personnel. Healthcare personnel is especially included in the support packages formed under the leadership of President Recep Tayyip Erdoğan.

In addition to increasing the number of healthcare personnel within the framework of the support, it was decided to improve the personal rights of healthcare professionals who fulfil their duties at risk, day and night. Furthermore, the precautions have been taken



regarding the working conditions of the healthcare personnel to prevent them and their families from the virus infection.

**With the support announced against the global pandemic, the Republic of Turkey has shown once again that it is together with our nation. Comprehensive support packages have been developed to minimize the negative effects of the global pandemic on our country's economy, security, tourism, trade, and business life. The "Economic Stability Shield" package includes several comprehensive measures for many parts of the society, from tradesmen to farmers, employers to employees, civil servants to retirees.**

**These support packages disappointed once again those who hope that Turkey would beg the IMF due to the global pandemic.**

The great courtesy of our citizens to the national solidarity campaign, launched with the slogan "We are self-sufficient, Turkey" by President Recep Tayyip Erdoğan on 03.30.2020, shows that as usual, our state and our nation hand in hand will overcome these challenging periods.

Our state and nation have revealed that no calamity is stronger than our unity and solidarity.

**BİZ BİZE YETERİZ  
TÜRKİYEM**

# Education

- To avoid the disruption of education due to coronavirus, the State of the Republic of Turkey has taken all necessary measures. At a time when millions of students worldwide are deprived of education,



**Turkey has succeeded in the test of the education field and become a pioneer among the countries adopting distance education.**



After the suspension of education due to the global pandemic, **Turkey started distance education.**

**The distance education program in Turkey is carried out through three separate television channels and EBA.**

- On television channels opened separately for primary, secondary, and high schools, the courses are broadcast continually until evening.



During this spring semester, there will be no face-to-face courses at universities. **It was decided to continue courses through distance education, open education, and digital education.**



The exams such as thesis defence and proficiency at universities can be performed **by video conferencing or similar digital methods provided that they are auditable and recorded.**



The additional capacity required for ULAKNET/Internet access **and distance education services of universities was provided by TÜBİTAK.**



To make information and resources available and accessible, the **online libraries and archives from around the world, as well as Turkey, have been opened to the service of readers. kullanımına açıldı.**



The dates of all exams held in our country were reviewed and rearranged.



**Dormitory fees will be refunded to 380 thousand university students and will not be charged in April, May, and June.**



Additional course fees for our **substitute teachers and master teachers will continue to be paid throughout this period.**

# Justice

— In line with the recommendations made by the Scientific Board on Coronavirus, various decisions were taken in the field of justice. The measures taken, on the one hand, ensure that citizens do not suffer a loss of rights; on the other hand, they reduce human mobility in the field of justice and contribute to the slowing down of the spread of the pandemic. And finally, as a result of the measures taken, human mobility in courthouses has decreased by an average of 95 percent.



Flexible working hours and shift systems were adopted in courthouses and regional courts.



**It was decided that the code of criminal procedure payments of attorneys would be made totally in April.**



All hearings except for detainees and urgent ones, suspension of execution, ending the period of limitation, and other urgent proceedings were postponed until April 30.



All enforcement and bankruptcy proceedings were suspended from March 22, 2020, to April 30, 2020.



The practice of notary office in-duty was suspended until further notice.



All the activities and work carried out collectively by convicts under probation were terminated.

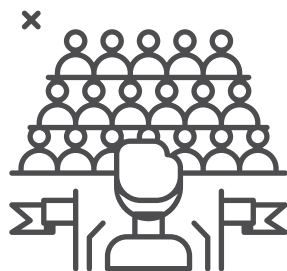

# 95%

As a result of the measures taken, human mobility in courthouses has decreased by an average of 95 percent.

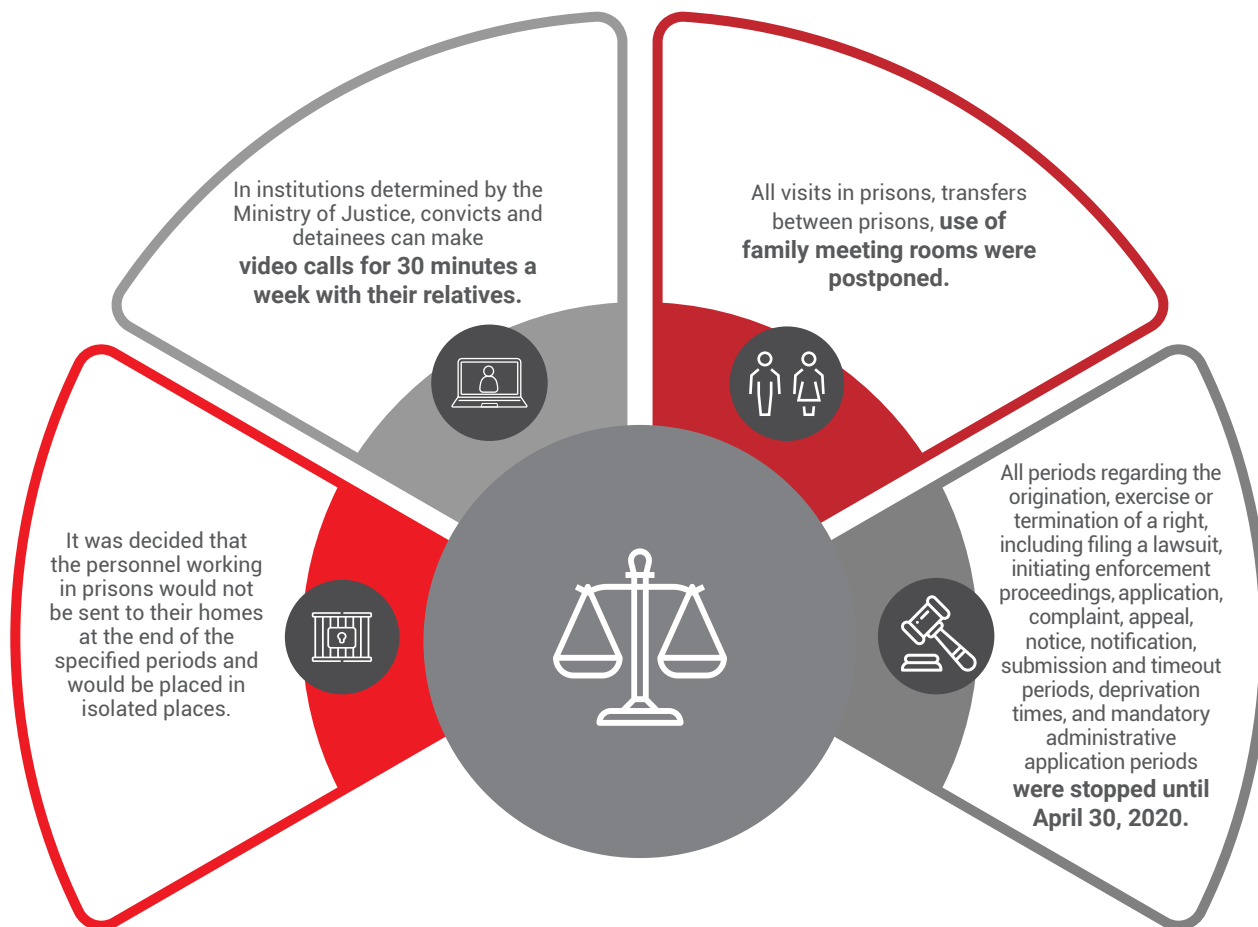

# Health

In this period, Turkey achieved some firsts all around the world as well as took highly important steps regarding healthcare personnel, the most significant component of the fight against the coronavirus pandemic.

## Performance Payments

Healthcare personnel's performance payments will be made **at the upper ceiling** for 3 months.

## Support of 1.2 Billion TL

It was **decided** to make the performance payments of the personnel in university hospitals at the ceiling level for **3 months**, and **1.2 billion TL** of additional support was allocated within this scope.

## Use of Guesthouses

Guesthouses of the state institutions will be **available for all healthcare personnel**.

## Domestic Ventilator

The **production** of domestic ventilators was **initiated**.



## 32,000 new personnel

32,000 new healthcare personnel  
will be appointed.

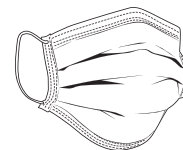

### Free Public Transportation

Healthcare personnel will benefit from **public transportation services free of charge.**



### First and Only in the World

#### Free Medical Mask

Turkey is the only state in the world that distributes **free masks to citizens.** With the collaboration of the Ministry of Health and the Ministry of Transport and Infrastructure, **free masks are distributed** every week to citizens aged 20-65.

### Work on Domestic Vaccine

The work on vaccine and drug development is ongoing.



### 2 New Hospitals with

#### 1000beds

Two new pandemic hospitals with **1,000 beds each** will be built in Istanbul to fight the coronavirus pandemic.



# Industry and Trade

- Significant support packages for SMEs were announced within the framework of the fight against coronavirus pandemic. Crucial decisions were taken regarding the production, import, and export of medical supplies, which play a key role in our country's fight against the pandemic.

## Techno Investment Support

- The enterprises manufacturing products such as disinfectant, protective clothing, safety glasses, mask, and gloves with local resources, will benefit from **TEKNOYATIRIM Support Program**.

## Production Support

- **Support of 6 million TL will be given by KOSGEB** to local producers of products such as disinfectant, protective clothing, protective glasses, masks, and gloves.

## Receivables Deferred

- Within the scope of KOSGEB's reimbursement support, receivables until 30 June were deferred for 3 months.

## Extension of Project Period

- In KOSGEB programs, additional **time up to 4 months was** given to the companies that have to fulfil their project obligations on March 11 and later.

## Rent Relief

- Rent payment **will not be demanded for 2 months** from Technopark management companies, enterprising companies, and commercial units such as restaurants and cafes located in technoparks.

## R&D Support

- TÜBİTAK **started to support** the products used in the diagnosis and treatment of Covid-19 **under the "SME R&D Initial Support Program"**.

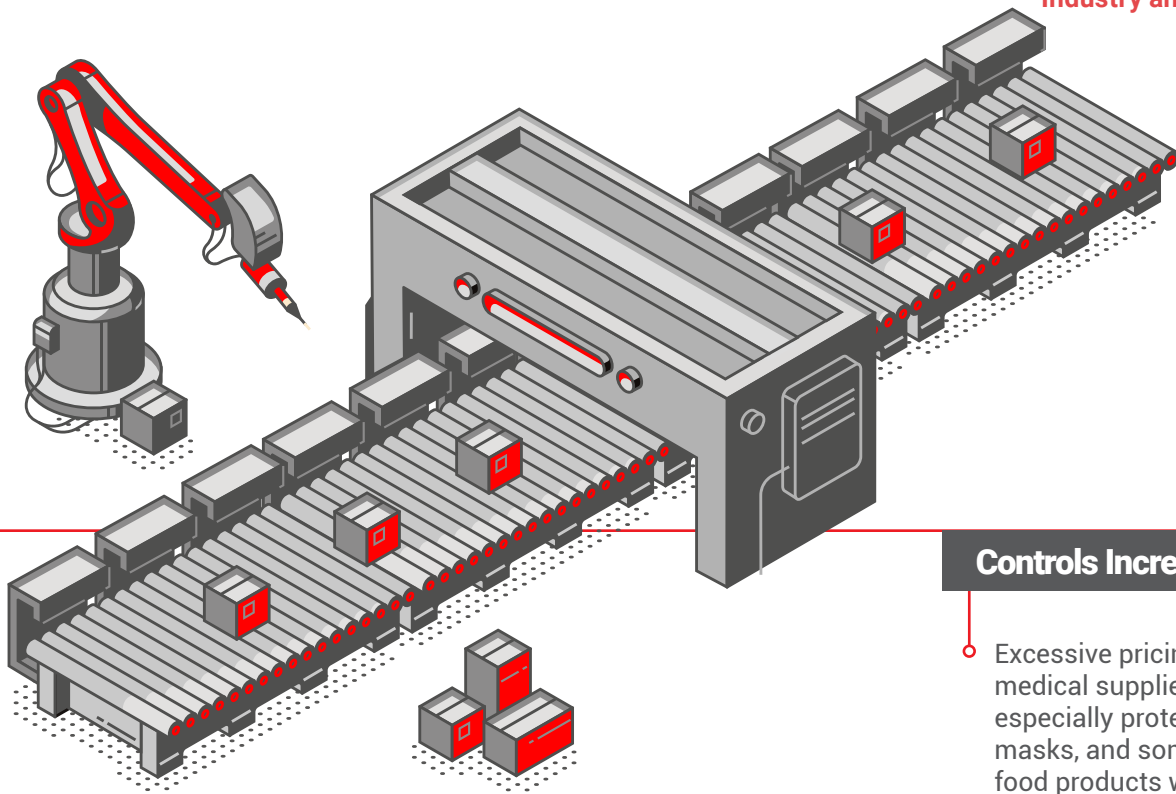

### Controls Increased

Excessive pricing in medical supplies, especially protective masks, and some food products were **strictly controlled** and profiteers of the pandemic were fined.

### Regulation on Customs Duty

Additional customs duty on medical masks **was lifted**.  
 Additional customs duty on ventilators **was lifted**.  
 The customs duty on the import of ethyl alcohol **was lifted**.

### Kredi Faiz Desteği

**Flexibility was introduced** to the practice of loan interest support provided in investment incentives.

### Export Limitation

**The authority over** the export license of ventilators was given to the Turkish Medicines and Medical Devices Agency.

# Banking

- Important support packages were provided in the banking sector through public banks in order to ensure that customers can overcome the coronavirus pandemic period with minimal financial loss.

## Halkbank

- Those who do not make the payments of instalment, interest, and principal until March 31, 2020, will be able to postpone their payments for this period.
- Corporate card limits of companies will be increased.
- Additional credit limit equal to the cost of employees' salaries will be provided to the companies during the 3-month period, on condition that they do not decrease the number of their employees.
- The grace period will be able to be extended up to 12 months in sectors with periodic activities such as tourism.
- The opportunity to restructure their loans with a maturity term with a grace period for up to 6 months will be offered to bank customers.
- Payments of merchants and craftsmen will be able to be postponed for 3 months without interest.

## Ziraat Bank

- Those who fail to make payments of instalment, interest, and principal until March 31, 2020, will be able to postpone their payments for this period.
- Corporate card limits of companies will be increased.
- Additional credit limit equal to the cost of employees' salaries will be provided to the companies during the 3-month period, on condition that they do not decrease the number of their employees.
- The grace period will be able to be extended up to 12 months in sectors with periodic activities such as tourism.
- Credits available will be able to be restructured with a grace period up to 6 months.



## Vakıf Bank

- Instalment and credit card payments of retail customers will be able to be deferred up to 3 months.
- "Check Payment Support Loan" was prepared in order to ensure that the checks made out by customers in the fields of Corporate, Commercial, and SME are paid.
- Flexibility was introduced for all principal and interest payments up to 30 June 2020, including companies' end of the quarter of interest rates on March 31, 2020.
- The cash management limits of the companies will be increased and the payments to be made at these limits will be provided with a 3-month grace period and up to 12 months of instalments.
- Sector-oriented loans, including tourism and inner-city public transportation, will be restructured for up to a 12-month grace period.
- The businesses will be provided with a long-term loan equal to the salary cost of 3 months.

Furthermore,

- **The basic need support package** was put into use through public banks for all our citizens whose monthly income is less than 5 thousand TL.
- **"Stay in Business" credit package** will be granted to all companies affected by the pandemic.
- **"Business and financial support"** and **"Paraf merchant card support"** packages are implemented by Halkbank for all our merchants.
- **By deferring the loan interest**, Halkbank eased the interest burden of approximately **90 million TL** for our merchants and craftsmen.
- Central Bank of the Republic of Turkey took **additional** measures to strengthen the monetary transmission mechanism against the economic and financial effects of coronavirus and to **support exporters of goods and services companies**.

# Economy and Finance

1.9  
MILLION

## Force Majeure Condition

- In addition to taxpayers operating in sectors that will benefit from force majeure, all income **taxpayers consisting of 1.9 million citizens were covered under force majeure condition.**

6  
MONTH

## Postponement

- The **price of easement rights and revenue share payments** related to hotel rentals were **postponed for 6 months** for April, May, and June.

50  
BILLION

## Resource of 50 Billion TL

- Within the scope of the Treasury Supported Credit Guarantee System, the amount of legal resources was increased from 25 billion TL and all of our small and large enterprises, experiencing a collateral shortage in accessing finance, were provided with loan support of over **450 billion TL in total** through the packages to be introduced.

AMOUNT OF LEGAL RESOURCE  
25 BILLION



WITH THE NEW  
ARRANGEMENT E  
**50 BILLION**

- The briefs, VAT, and premium payments (approximately TL 53.6 billion) of **more than 2 million taxpayers were deferred for 6 months.**

## Financing Support

- Financing support was provided by delaying for a **minimum of 3 months** the **loan payments** of companies and natural persons suffering from cash flows deterioration.
- **Flexibility was introduced** in delays in credit payments.
- In order to maintain capacity utilization rates during the temporary slowdown in **exports**, exporters were **given more than 1 year to disinvest.**
- The companies in default were provided to have a "force majeure" note in their registry.

LOAN  
PAYMENTS  
WILL BE  
DEFERRED FOR  
3 MONTHS.



The house purchasing opportunities under more favourable conditions were provided to the citizens.



The accommodation tax was postponed to January 2021



The VAT rate in domestic airline transportation was reduced from **18% to 1% for 3 months**

### Tax Deferral for those aged 65 and over

- Tax returns and payments were deferred **until the end of the curfew** for taxpayers, who are unable to leave their homes for being over the age of 65 and due to their chronic illnesses.



### Deferment of Tax Statement

The due dates of tax statements and tax payment accrued were **deferred**.

### Payment Flexibility

Support and flexibility were introduced **for rental payments** of leased immovable properties that belong to or are at the disposal of special provincial administrations, municipalities, and their affiliates.

### 3 Billion TL Additional Funding

3 billion TL deduced from the tax share revenues of municipalities in return for their debts **will not be cut back for 3 months** (April-May-June). This **provided additional funding of 3 billion TL for municipalities**.

### Debts owed to SMEs

The scope of state-funded credit insurance was extended and **debts owed to SMEs were guaranteed**.

### Loan Deferral

**Bank loans** of 136 thousand enterprises will be **deferred by 3 months**.

# Business and Social Life

## Salary Increase for Retirees

The lowest pension was increased from 1.000 TL to 1.500 TL. Thus, the pensions of nearly **650 thousand retirees** were increased.

## Payments at Home

State banks will make pension payments of retirees **at their homes if they wish so.**

## Eid al-Fitr Bonus Payment

Retirees started to receive their bonus payments for Eid al-Fitr in **early April.**

## Minimum Wage Support

Minimum wage support of 75 TL will be provided for 12 months regardless of the size of enterprises. Around **7.8 million people** will make use of this support.

## Remote Work

The flexible and remote working model was introduced for the public and private sectors.

## Short-time Work Allowance

**Short-time work allowance** was introduced to prevent dismissals at workplaces affected by coronavirus.



### 1,000 TL Aid in Cash

A fund of 2 billion TL was put into use for aid in cash amounting to 1,000 TL for 2 million 111 thousand households in need.

### Salary Support

Salary support will be provided for 3 three months to citizens working for enterprises that have reduced or ceased their activities through short-time working allowance.

### Compensatory Work

Compensatory work period was extended to 4 months, which supported the continuity of employment.

### Assistance to Households

Assistance will be provided to 2 million 300 thousand households in need.





## **TURKEY'S INTERNATIONAL AIDS AND EVACUATIONS**

# Turkey's International Aids and Evacuations

Turkey does not keep its fight against coronavirus only within its national borders, but contributes to the fight conducted by many states in terms of the financial and medical supply aspects so as to slow down the spread of the pandemic that has turned to a global problem and to prevent losses of lives.

During the coronavirus process, Turkey has received requests for medical supplies aid from 150 countries under such topics as "donation," "financial aid," "export" and "purchase permits" so far. 119 countries requested donations, 22 countries requested financial aid, 52 countries requested purchase permits, and 73 countries requested export licenses.

Turkey has so far donated numerous and a great variety of health supplies, in particular approximately 11,000,000 masks, nearly 600,000 N95 masks, over 110,000 face shields, around 750,000 protective overalls and approximately 650,000 gloves, to the countries suffering shortages of protective equipment and supply and requesting assistance. In addition, prioritizing diagnostic and treatment supply support, Turkey has also provided the countries in need with more than 200 ventilators.

Turkey has met request from 125 countries and three international organizations (OCHA, PAF and UNICEF). Of the requests by the said countries that were met, 104 were donations, 58 were purchase permits and export licenses. In addition, six countries have been provided with financial aid.

Within the scope of the global fight against coronavirus, medical supply needs of 40 countries in Europe, 31 in Africa, 26 in Asia and 14 in America and Oceania were met.

EUROPE	40
AFRICA	31
ASIA	26
AMERICA	14
OCEANIA	14

**COUNTRIES MAY HAVE REQUESTS UNDER MORE THAN ONE CATEGORY - DONATION, AID, PURCHASE PERMIT/EXPORT LICENSE.**

1. USA	19. Djibouti	37. Guyana	55. Montenegro
2. Afghanistan	20. Cook Islands	38. Republic of South Africa	56. Qatar
3. Germany	21. Chad	39. South Sudan	57. Kazakhstan
4. Andorra	22. Czech Republic	40. Georgia	58. Kenya
5. Angola	23. People's Republic of China	41. Haiti	59. Kyrgyzstan
6. Argentina	24. Dominican Republic	42. Croatia	60. Kiribati
7. Albania	25. Equatorial Guinea	43. The Netherlands	61. Turkish Republic of Northern Cyprus (TRNC)
8. Austria	26. El Salvador	44. Iraq	62. Colombia
9. Azerbaijan	27. Eritrea	45. Britain	63. Comoros
10. Bahrain	28. Ethiopia	46. Iran	64. Kosovo
11. Bangladesh	29. Morocco	47. Ireland	65. Kuwait
12. Belarus	30. Fiji	48. Spain	66. North Macedonia
13. Belgium	31. Ivory Coast	49. Sweden	67. Lesotho
14. Bolivia	32. Philippines	50. Switzerland	68. Libya
15. Bosnia and Herzegovina	33. Palestine	51. Israel	69. Lithuania
16. Brazil	34. France	52. Italy	70. Lebanon
17. Bulgaria	35. Gambia	53. Cameroon	71. Hungary
18. Algeria	36. Guinea	54. Canada	

# Turkey's International Aids and Evacuations

**COUNTRIES MAY HAVE REQUESTS UNDER MORE THAN ONE CATEGORY - DONATION, AID, PURCHASE PERMIT/EXPORT LICENSE.**

72. Madagascar	85. Niger	99. Russia	113. Tanzania
73. Malta	86. Nigeria	100. Samoa	114. Tonga
74. Marshall Islands	87. Niue	101. San Marino	115. Tunisia
75. Mexico	88. Norway	102. Senegal	116. Tuvalu
76. Micronesia	89. Uzbekistan	103. Serbia	117. Turkmenistan
77. Mongolia	90. Pakistan	104. Sierra Leone	118. Uganda
78. Moldova	91. Palau	105. Slovakia	119. Ukraine
79. Principality of Monaco	92. Papua New Guinea	106. Slovenia	120. Oman
80. Mauritania	93. Paraguay	107. Solomon Islands	121. Vanuatu
81. Mauritius	94. Peru	108. Somalia	122. Vatican
82. Mozambique	95. Poland	109. Sudan	123. Venezuela
83. Namibia	96. Portugal	110. Syria	124. Vietnam
84. Nauru	97. Romania	111. Saudi Arabia	125. Yemen
	98. Rwanda	112. Tajikistan	

Turkey has also announced a donation of about 5 million USD to Palestine during a meeting of the Organization of Islamic Cooperation Executive Committee on April 22.

Examples of the support provided by Turkey in this process are presented below.



## USA

● Turkey dispatched 500,000 medical masks, 500 face masks, 1,500 eye protectors, 400 N95-type masks, 80,000 overalls, 2,000 litres of disinfectant to the USA so as to provide medical supplies on April 28-30, 2020.

Turkey sent 15,000 pieces of surgical masks to our Consulate General in New York for the use of Turkish citizens on May 8, 2020. In addition, at the request of Turkish citizens in Maryland, 30,000 surgical masks were sent to the Embassy of the Republic of Turkey in Washington on May 11, 2020.

# Turkey's International Aids and Evacuations

## GERMANY

• The grant agreement concluded by Turkey with Germany includes 5,000,000 mouth/face masks, and in this context, 1,204,500 masks have been sent and we continue to keep sending.

Furthermore, 40,000 masks were donated to Hannover Municipality on May 2, 2020. The mentioned masks were delivered to the logistics centre affiliated to Hannover Regional Clinics by the Turkish Consulate General on May 4.



**Turkey with Germany includes 5,000,000 mouth/face masks, and in this context, 1,204,500 masks have been sent and we continue to keep sending.**

## ALBANIA

• Turkish Red Crescent (Kızılay) sent 75,000 three-layer surgical masks, 4,000 powder-free nitrile gloves, 2,000 protective overalls and 2,000 protective goggles to Albania on May 12, 2020.

Furthermore, 40,000 masks were donated to Hannover Municipality on May 2, 2020. The mentioned masks were delivered to the logistics centre affiliated to Hannover Regional Clinics by the Turkish Consulate General on May 4.



## • AUSTRIA

• The cargo containing 50,000 surgical masks shipped by Turkey was received by the Embassy of the Republic of Turkey in Vienna on June 2, 2020 and delivered to Vienna Municipality.

Furthermore, 40,000 masks were donated to Hannover Municipality on May 2, 2020. The mentioned masks were delivered to the logistics centre affiliated to Hannover Regional Clinics by the Turkish Consulate General on May 4.

## • AZERBAIJAN

• Turkey has provided Azerbaijan with 250 diagnostic kits and donated 10 tons of concentrated disinfectant.

As part of the measures against the pandemic, the Turkish Cooperation and Coordination Agency (TİKA) distributed 600 parcels of basic foodstuffs to Turkish and Azerbaijani families in need on May 14, 2020, as people over the age of 65 could not go out and some shopkeepers had to close their shops temporarily. In addition, food/cleaning materials were provided to 2,000 families on April 7, 2020 and 44 tons of food aid was provided to around 2,500 families in more than 30 settlements during the month of Ramadan.

Azerbaijani physicians/medical students were trained in Ege University in İzmir within the scope of combating Covid-19, and following the training, they started to contribute to the fight against the pandemic in Azerbaijan.

# Turkey's International Aids and Evacuations

## • BANGLADESH

• 3,000 food parcels have been delivered by Turkey for the use of the Dhaka North City Corporation (DNCC) in its aid program for the people in need in Dhaka.

TİKA has provided 70 tons of food aid and 5,000 hygiene packages to Arakanese Muslims. It has also distributed Ramadan packages to 1,000 families in need in the rural area of Chakaria in Bangladesh.

TİKA's support packages consisting of 5,000 surgical masks, 1,000 N95 masks, 1,000 medical overalls and two ventilators have been delivered to the officials at the Bangladesh State Guest House.

Turkey has donated to the field hospital serving to Rohingya refugee camps in Cox's Bazar 90 taped seam overalls, 4,700 surgical masks, 175 N-146 masks, 50 protective shields, 500 aprons, 40 safety goggles as protective equipment and 35 pieces of Favipiravir, 480 pieces of Tamiflu, 160 pieces of Plaquenil and 175 rapid testing kits as medications/tests.



**TİKA's support packages consisting of 5,000 surgical masks, 1,000 N95 masks, 1,000 medical overalls and two ventilators have been delivered to the officials at the Bangladesh State Guest House.**



 **TİKA has provided 70 tons of food aid and 5,000 hygiene packages to Arakanese Muslims. It has also distributed Ramadan packages to 1,000 families in need in the rural area of Chakaria in Bangladesh.**

## Turkey's International Aids and Evacuations



### UNITED KINGDOM

Under the grant agreement signed on April 7, 2020 between Turkey and the United Kingdom of Great Britain and Northern Ireland, Turkey has donated 50,000 N95 masks, 100,000 surgical masks and 100,000 protective overalls.

Kızılay has donated 40,000 three-layer surgical masks, 30,000 powder-free vinyl gloves, 4,400 EN149 masks, 400 protective overalls and 500 safety goggles.

Turkey further delivered 58,000 masks, 28,000 face protectors and 85,270 overalls between April 10 and 12, 2020.

Embassy of the Republic of Turkey in London was sent 20,000 surgical masks and 1,000 overalls on May 5, 2020 for the use of Turkish citizens in the country with higher number of cases.

 **Turkey further delivered 58,000 masks, 28,000 face protectors and 85,270 overalls between April 10 and 12, 2020.**

## —• BOSNIA AND HERZEGOVINA

• Turkey sent 1,500 testing kits, 50,000 surgical masks, 50,000 powder-free vinyl gloves, 10,000 N149 masks, 500 protective overalls, 500 protective goggles and 5,000 powder-free gloves to Bosnia and Herzegovina via Kızılay on March 24, 2020.

Upon the instructions of President Recep Tayyip Erdoğan, 100 thousand three-layer masks, 2,000 overalls and 1,500 diagnostic kits were also donated to the country on April 8, 2020.

Within the scope of the fight against the Covid-19 pandemic and Ramadan activities, TİKA has distributed food and hygiene supplies to 1,000 families in need in Bosnia and Herzegovina. In cooperation with TİKA and the International University of Sarajevo, 3D-printed face shields were manufactured to be distributed to healthcare professionals. 500 face shields manufactured under the project were distributed to health institutions and other partners in the country.

TİKA distributed food and hygiene supplies to 1,000 needy families in Bosnia Herzegovina as part of the Kovid-19 outbreak and Ramadan activities. In cooperation with TİKA and the International University of Sarajevo, a face mask was produced with a 3D printer to be distributed to healthcare professionals. 500 protective trench masks produced under the project were distributed to health institutions and other partners in the country.

For the purpose of both fulfilling the donation requirements in endowments and helping the people adversely affected by the Covid-19 pandemic throughout the world, Turkey supplied 5,000 dry food parcels to Sarajevo for the families in need in Bosnia and Herzegovina on May 19, 2020.

## Turkey's International Aids and Evacuations



### ● BULGARIA

● At the request of Bulgarian Prime Minister Boyko Borisov, 20 boxes of medication were sent as grant by diplomatic cargo on April 8, 2020.

TİKA launched its Food Aid Program for over 10,000 Turkish, Bulgarian, Pomak and Roman people living in 20 different cities of Bulgaria (Sofia, Vidin, Pleven, Pazardzhik, Gotse Delchev, Plovdiv, Smolyan, Kardzhali, Haskoy, Old Zagora, Veliko Tarnovo, Ruse, Razgrad, Targovishte, Sliven, Shumen, Silistra, Aytos, Varna and Dobrich) on the occasion of the month Ramadan. Within the scope of the program supported by TİKA and under the auspices of the Embassy of the Republic of Turkey in Sofia and organization of the Republic of Bulgaria Muslim Denomination, distributions were conducted with the participation of officials from the Embassy in Sofia, Consulate General in Plovdiv, Consulate General in Burgas and Regional Muftis.

For the Turkish cognates in Kardzhali, Turkey has sent 10,000 surgical masks and 3,000 diagnostic kits.



## PEOPLE'S REPUBLIC OF CHINA

● Within the scope of Turkey's international fight against Covid-19 pandemic, two aid cargoes consisting of 2,000 N95 masks, 2,000 protective overalls, 2,000 goggles, disinfectants, gloves and shoe covers were shipped to China between February 1, 2020 and February 13, 2020. In addition, three tons of medical aid supplies were sent to China on February 13, 2020, and the aid supply containing the masks and protective overalls was delivered to the Embassy of the Republic of Turkey in China on February 18, 2020.



# Turkey's International Aids and Evacuations

## PALESTINE

● Turkey announced a donation of about 5 million US to Palestine during a meeting of the Organization of Islamic Cooperation Executive Committee on April 22.

Turkey had donated 15 tons of supplies consisting of 40,000 PCR diagnostic kits, four PCR machines, 100,000 N95 masks, 40,000 overalls, 100,000 gloves, 2,000 oxygen masks, 20,000 nasal cannula, two tons of hand disinfectant and 20,000 shields to be delivered to Ramallah and Gaza and dispatched them on April 20, 2020. The aid materials were withdrawn from the customs by the Palestinian Ministry of Health and taken to Ramallah on May 5, 2020.

Six tons of hygiene materials and personal protective equipment have been sent to the Palestinian Ministry of Health by TİKA. Food aid was provided for 5,060 families in Gaza and 7,500 families in West Bank and East Jerusalem. Financial aid of 25,000 USD has been provided by Kızılay.



**Turkey had donated 15 tons of supplies consisting of 40,000 PCR diagnostic kits, four PCR machines, 100,000 N95 masks, 40,000 overalls, 100,000 gloves, 2,000 oxygen masks, 20,000 nasal cannula, two tons of hand disinfectant and 20,000 shields to be delivered to Ramallah and Gaza and dispatched them on April 20, 2020.**

## FRANCE

- Based on requests for grant, the aid materials containing 40,000 three-layer surgical masks and 1,000 medical overalls were sent to our Embassy in Paris to be delivered to relevant authorities on April 24, 2020.

The French Polynesia and New Caledonia regions, which are essentially a part of France and also members of the Pacific Islands Forum (PAF), have been sent 10,000 masks and 10,000 refreshing towels by Turkey through the PAF Secretariat.



## REPUBLIC OF SOUTH AFRICA

- Upon a request for overalls, masks, gloves, test kits and two-three mobile sterilization bellows by the Republic of South Africa, 100,000 masks, 500 protectors, 500 eye protectors, 100 pieces of N95, 500 overalls and 200 disinfectants were delivered to the Republic of South Africa by a military aircraft on April 29, 2020.

10,000 N95 masks have been delivered for the Kalafong Hospital by TİKA.

# Turkey's International Aids and Evacuations

## GEORGIA

• 50,000 three-layer surgical masks, 50,000 powder-free vinyl gloves, 2,000 N149 masks, 500 protective overalls and two 56 m<sup>2</sup> air-ducted inflatable tents were delivered to Georgia on April 22, 2020.

TİKA has provided support for the construction of the Batumi Infectious Diseases Hospital, distributed domestically-produced 15,000 masks and 30,000 breads and delivered a total of 40 tons of food aid to 2,500 families living in the regions of Ahiska, Adjara, Kakheti, Kvemo Kartli, Imereti and Samegrelo in Georgia.

Turkey has also provided food aid for the cities of Gardabani, Rustavi, Dmanisi, Bolnisi, Garchomp, Marneuli, Guria, Batumi, Ahiska and Tbilisi in collaboration with various organizations in Georgia.

## CROATIA

• TİKA provided 200 parcels of food materials for the needy people in the Vukovar-Srijem County on the occasion of Ramadan on May 15, 2020. Furthermore, 1,100 food parcels amounting to 50,000 Euros were delivered to those in need with distributions in Karlovac, Gospic, Sisak, Sibenik and Zagreb.



## IRAQ

### Iraqi Kurdish Regional Government (IKBY)

As part of the fight against the novel coronavirus in Iraq, Kızılay has provided the Arbil Governorate of Iraq with 30,000 masks and 475 parcels of food. In addition to 20,000 masks sent on the day when the pandemic was initially confirmed, 10,000 masks were delivered as the second batch on March 19, 2020. Furthermore, 475 parcels of food were prepared to be distributed to poor families in Erbil, where the curfew was imposed.

Under the coordination of TİKA Baghdad Program Coordination Office and the Iraqi Red Crescent Office in Arbil, 2,000 parcels of food aid were distributed in Arbil. In addition, the requests for hygiene materials, masks, beds, tents and spraying machines made by the Iraqi Red Crescent from Kızılay were met on March 08, 2020.



## Turkey's International Aids and Evacuations

### **Mosul**

The hygiene package consisting of 3,000 masks, 1,000 pieces of 100-gr soap and 1,000 pieces of 500 ml sattol were delivered to the Mosul Provincial Directorate of Health on March 29, 2020.

Within the scope of Ramadan aids, food packages prepared for 5,000 needy families in Iraq were distributed by TİKA in provinces such as Mosul, Tal Afar, Diyala and Salahaddin.

### **Kirkuk**

18,000 protective masks were delivered by the Turkish Red Crescent to officials from the Governorate of Kirkuk and the Iraqi Turkmen Front on March 25, 2020.



## IRAN

As part of the grant agreement signed between Turkey and Iran on March 16, 2020, 1,000 diagnostic kits, 4,715 overalls, 20,000 aprons, 2,004 goggles, 4,000 N95 masks and 78,000 three-layer masks have been donated.

 **4,000 N95 masks and 78,000 three-layer masks have been donated.**



## Turkey's International Aids and Evacuations

### SPAIN

● Turkey has delivered an aid package consisting of 250,000 masks, 250 facial protectors, 750 protective eye masks and 2,000 overalls to Spain by a military aircraft on April 1, 2020.

With the support of TİKA and in cooperation with the Granada Mosque Foundation, food parcels were distributed to 100 Muslim families in need every Friday throughout the month of Ramadan in the city of Granada in the Andalusia region.

✓ **Turkey has delivered an aid package consisting of 250,000 masks, 250 facial protectors, 750 protective eye masks and 2,000 overalls to Spain by a military aircraft on April 1, 2020.**



## ITALLY

● In the context of combating the Covid-19 pandemic, Italy has called for assistance through the Euro-Atlantic Disaster Response Coordination Centre (EADRCC) of NATO. Turkey delivered an aid package consisting of 200,000 masks, 250 protective face masks (panoramic), 750 protective eye masks, 2,000 overalls and 1,000 litres of antibacterial liquid to Italy on April 1, 2000.

✓ **Moreover, the Turkish Red Crescent sent medical supplies consisting of 100,000 three-layer surgical masks, 100,000 powder-free vinyl gloves, 20,000 EN149 masks, 1,500 protective overalls and 1,500 protective goggles to Italy.**



# Turkey's International Aids and Evacuations

## KAZAKHSTAN

• Three pieces of breathing apparatus was donated by Turkey to Kazakhstan. Turkey sent an aid package consisting of 400 atropine ampoules, 500 bottles of piperacillin and tazobactam, 1,500 azithromycin tablets, 150 rifampicin ampoules, 3,200 acetylcysteine tablets, 5,000 bottles of acyclovir and 500 dichloride tablets to Kazakhstan as grant by a cargo aircraft of the THY on April 18, 2020.

50,000 masks, 50 face shields, 100 pieces of eye protector, 50 pieces of N95, 300 overalls and 200 litres of disinfectant were sent to Kazakhstan by Turkey as grant on May 9, 2020.

TİKA donated 300 parcels of food to the families in need in Almaty on May 20, 2020.

TİKA and the Embassy of the Republic of Turkey in Nur-Sultan have distributed food supplies and antiseptic materials to 500 families in cities of Nur-Sultan and Almaty.

Turkey's Directorate of Religious Affairs representative has provided 80 families and 20 visually impaired people with food supplies as grant.

The medical supplies prepared by our Ministry of National Défense upon the instructions of President of the Republic of Turkey Recep Tayyip Erdoğan and donated to the Republic of Kazakhstan were delivered to the Kazakh authorities with a ceremony on May 11, 2020.



## • KIRGHIZSTAN

● In order to ensure the commissioning of Turkey-Kyrgyzstan Friendship Hospital, it was temporarily transferred to Kyrgyzstan and 200 test kits, 100 protective overalls, 100 N95 masks and 5,000 surgical materials were donated to the hospital.

Turkey has provided assistance with 200 diagnostic kits, 100 protective clothing, 100 goggles, 100 N95 masks and 20,000 surgical masks. In the early days of the coronavirus pandemic, TİKA has provided medical protection materials such as 4,500 masks, 4,500 gloves, 600 overalls, 500 protective goggles, 500 protective shields, 1,100 pieces of antiseptic, 30,000 pieces of 400 PCR test kits for hospitals in Kyrgyzstan. In addition, it has distributed 500 aid parcels containing food and hygiene materials. In the month of Ramadan, as part of the fight against the coronavirus pandemic in Kyrgyzstan, it delivered food aid also consisting of 10 masks and antiseptics to 7,000 families.

The Infectious Diseases Unit of Batken Hospital, the repair of which is undertaken by TİKA, is currently used as a base for combating Covid-19 in Batken. A fund has been created with the voluntary contributions from the salaries of the officials from our Embassy and our public employees in the Republic of Kyrgyzstan and support has been also provided for the fund by the Turkish and Kyrgyz companies operating in the Republic of Kyrgyzstan.

# Turkey's International Aids and Evacuations

## KOSOVO

Under the grant agreement signed by Turkey on March 20, 2020, Turkey has delivered four defibrillators (biphasic), 15 folding stretchers, 10 emergency trolley with drawers, seven dirty linen carriages, seven EMMA emergency capnometers, five sidearm patient stretchers, five portable patient monitors, five equipped pulseoxymeters, three automatic external defibrillators, five emergency response bags, 50,000 FFP2-3/N95 masks, 500 face shields, 20,000 protective overalls and 300 facial protectors to Kosovo.

Within the scope of NATO Solidarity, 100,000 masks, 2,000 overalls and 1,000 diagnostic kits were sent on April 8, 2020.

As part of the grant aid, Kızılay sent 20,000 three-layer surgical masks, 30,000 powder-free vinyl gloves, 1,560 N149 masks, 200 protective overalls and 100 protective goggles on April 8, 2020.

Furthermore, TİKA has delivered parcels of food aid to 1,600 families in need.



## TRNC

● Besides the initial financial resources totalling 72 million TL provided by Turkey for the TRNC for its urgent requirements, 70,000 surgical masks, 6,000 protective masks, 30,000 powder-free vinyl gloves, 500 protective overalls, 500 protective goggles, 5,000 swabs, four boxes of medication, 3,000 sample tubes, 550 visors and 2,000 blue surgical aprons were donated to the TRNC during the pandemic process.

Within the scope of the fight against the Covid-19 pandemic and as part of the Ramadan events, TİKA has provided the needy families in the TRNC with food aid. In Nicosia, Kyrenia, Famagusta, Morphou and Lefke regions, 25 tons of food materials have been delivered to 1,000 families in need. In addition, TİKA has provided the Disability Solidarity Association with hygiene equipment.

## NORTH MACEDONIA

● Turkey sent aid materials consisting of 50,000 masks, 1,000 overalls and 1,000 diagnostic kits to North Macedonia on April 8, 2020.

The Turkish Red Crescent delivered 75,000 three-layer surgical masks, 10,000 powder-free nitrile gloves, 2,000 protective overalls, 2,000 protective goggles and 2,000 EN149 masks (with valves) to North Macedonia within the scope of the fight against the pandemic on May 12, 2020.

TİKA provided 2,500 food and cleaning parcels and distributed 3,500 aid parcels on April 12, 2020.

## Turkey's International Aids and Evacuations



### LIBYA

Within the scope of the fight against the Covid-19 pandemic, 150,000 masks, 60 protective face masks (panoramic), 300 protective eye masks, 600 overalls and 400 litres of disinfectant liquid were sent to Libya.

Turkey sent the second batch of aid consisting of 200,000 masks, 70 face shields, 300 pieces of eye protector, 120 N95 masks, 600 overalls and 400 litres of disinfectant to Libya on May 7, 2020.

### HUNGARY

The Foreign Economic Relations Board (DEİK), along with contributions from the Turkish companies that are members of the Turkey-Hungary Business Council, sent three trucks filled with aid materials containing domestically-produced 50,000 plastic face shields, 16,000 bottles of gel hand disinfectant and 20,000 bottles of lemon cologne to Hungary on June 29, 2020.

## ● MOLDOVA

● In accordance with the “Agreement on Donation in the Field of Health” signed between the Government of the Republic of Turkey and Government of the Republic of Moldova upon the requests made by Moldovan authorities, 30,000 N95 masks, 10,000 overalls, 5,000 protective goggles, 10,000 pairs of gloves, 10,000 shoe covers and one ton of hand disinfectant were provided on April 23, 2020.

TİKA has delivered 10,000 disposable masks, 20,000 disposable gloves, one ton of disinfection solution, 250 face shields, 250 protective goggles, 1,000 N95 masks to Moldovan authorities.

TİKA has also provided protective medical supplies to health and safety personnel, and food and cleaning materials to 1,000 families.

Kızılay provided an aid consisting of 30,000 surgical masks, 10,000 gloves, 5,000 N149 masks and 500 protective overalls on May 11, 2020.

### **Gagauzia:**

Half of the medical protective supplies donated by Kızılay to the Moldovan Red Cross within the scope of the fight against the coronavirus pandemic were delivered to the hospitals and people in need at the Autonomous Territorial Unit of Gagauzia by the Red Cross on May 21, 2020.

# Turkey's International Aids and Evacuations

## NIGER

● Turkey granted 10,000 surgical masks, 1,000 N95 masks, 100 overalls, 500 protective goggles, 10,000 gloves, 1,000 litres of disinfectant, 400 tests, 50 medications and 100 face shields to Turkey-Niger Friendship Hospital on April 27, 2020.

Within the context of the grant agreement signed between the Republic of Turkey and the Republic of Niger, 50,000 surgical masks, 50,000 overalls, 30,000 N95 masks and 2,000 protective goggles were sent to Niger by a military aircraft on June 4, 2020.

Moreover, 20 ventilators donated by a Turkish company were also delivered to Niger on the same date.



**Within the context of the grant agreement signed between the Republic of Turkey and the Republic of Niger, 50,000 surgical masks, 50,000 overalls, 30,000 N95 masks and 2,000 protective goggles were sent to Niger by a military aircraft on June 4, 2020.**



## • UZBEKISTAN

• 50 domestically-produced ventilators granted by Turkey to Uzbekistan upon the instructions of Turkish President Recep Tayyip Erdoğan were delivered to Tashkent on May 22, 2020.

Within the scope of the humanitarian aid, Uzbekistan was provided with 200 special clothes, 50,000 masks and 200 shields in April.

The health set consisting of 5,000 protective clothes, goggles, masks, gloves and shoe covers prepared by TİKA was delivered to the National Health Centre of the Republic of Uzbekistan on April 30, 2020. The second parcel of TİKA aid consisting of 13 tons of food was delivered on May 22, 2020.

## Turkey's International Aids and Evacuations



### PAKISTAN

• The aircraft sent by Turkey to Pakistan carrying 20,000 N95 masks, 50,000 overalls and 100,000 medical masks reached Islamabad on April 22, 2020.

The second part of Turkey's aid to Pakistan consisting of 108,000 surgical masks and 31,500 pieces of protective equipment was delivered to Karachi by a Turkish Airlines cargo aircraft of the Turkish Airlines (THY) on April 28, 2020.

Within the scope of the fight against the Covid-19 pandemic, TİKA reached 22 thousand 500 people with the help of a total of four thousand parcels and 70 tons of food during the month of Ramadan.



**TİKA reached 22 thousand 500 people with the help of a total of four thousand parcels and 70 tons of food during the month of Ramadan.**



## PARAGUAY

● Within the framework of the grant agreement signed by Turkey with Paraguay on June 5, 2020, Turkey has sent 50,000 protective overalls, 30,000 N95 masks, 100,000 surgical masks, 2,000 protective goggles, 50,000 shoe covers and 50,000 gloves to Paraguay.

# Turkey's International Aids and Evacuations

## PERU

• The hospital supplies containing two double infusion pumps, 15 pressure beds, 22 multipurpose steel wheeled medication and equipment trolleys, 10 examination table steps, 10 steel pedal bins and five emergency service trolleys, requested by the Tumbes Governorate in northern Peru from TİKA through the Embassy of Peru in Ankara has been shipped to the Governorate of Tumbes.

## ROMANIA

• 50,000 three-layer surgical masks and 1,500 EN149 FFP2-type masks were delivered to Romania by Kızılay on May 30, 2020.

On the occasion of the month Ramadan, TİKA presented sports bags consisting of hygiene supplies and sportswear to 181 orphans, disabled and children in need who were in quarantine in Romania due to the pandemic.



## • SERBIA

• Upon the instruction of Turkish President Recep Tayyip Erdoğan, 100,000 masks, 2,000 overalls and 1,500 diagnostic kits have been delivered to Serbia within the scope of the NATO Solidarity. 500 test kits were donated on April 8, 2020. TİKA distributed the domestically manufactured soap and disinfectant products in Sandzak, and on the occasion of the month Ramadan, distributed aid parcels containing a total of 15 tons of basic food supplies to 1,000 families formed of people in need and disadvantaged groups such as Romans and refugees. Three tons of food were also delivered to the Karnyacha Refugee Camp near Belgrade in collaboration with the Commissioner for Refugees and Displaced Persons of Serbia (KIRS). The Friends of Sandzak Platform located in our country and the Foreign Economic Relations Board of Turkey (DEİK) Turkey-Serbia Business Council have donated 20,000 masks, 2,000 protective clothes and hygiene supplies for the pandemic hospital established in the Sandzak region and the hospitals in Novi Pazar, Tutin, Sjenica and Prijepolje.

Turkey has also sent 10 bedside monitors, 20 pulseoxymeters (finger), 10 UV sterilization lamps, 50 oxygen regulators, 10 perfusion pumps, one video laryngoscope, three laryngoscopes (three fiber optic blades), 10 silicone ambu, three surgical aspirators (double jars), 400 hospital bedding sets, 30 intensive care patient cots (three motors), 20,000 protective masks (FFP2) and 2,000 protective overalls to Serbia.

## • TAJIKISTAN

• Turkey delivered an aid of 50,000 medical masks to Tajikistan on May 25, 2020. 70,000 protective masks and 1,000 medical coveralls provided by TİKA for people in the risk group, in particular healthcare professionals, were delivered to the Ministry of Health and Social Protection of Tajikistan on June 4, 2020.

# Evacuations Carried Out By The Republic of Turkey During Covid-19 Pandemic

Upon the instruction of President Recep Tayyip Erdoğan, Turkey has performed the greatest evocation operation in the history of the Republic. To date, approximately 70,000 thousand Turkish citizens from 128 countries have been returned to the country.

- Firstly, more than 25,000 Turkish citizens, who are in temporary status in the countries listed below, were brought from 71 countries to Turkey on April 14, 2020:

The United States, Afghanistan, Germany, Argentina, Austria, Azerbaijan, Belarus, Belgium, United Arab Emirates, United Kingdom, Bulgaria, Algeria, Czechia, People's Republic of China, Denmark, Dominican Republic, Ethiopia, Morocco, the Philippines, France, Guinea, South Africa, South Korea, India, the Netherlands, Honduras, Iraq, Iran, Ireland, Spain, Israel, Sweden, Switzerland, Italy, Cambodia, Canada, Montenegro, Qatar, Kazakhstan, Kenya, TRNC, Colombia, Kuwait, North Macedonia, Libya, Lebanon, Luxembourg, Egypt, Mongolia, Moldova, Mauritania, Norway, Uzbekistan, Pakistan, Panama, Poland, Portugal, Romania, Russian Federation, Singapore, Serbia, Sri Lanka, Sudan, Syria, Saudi Arabia, Thailand, Tunisia, Ukraine, Venezuela, Cape Verde Islands and Greece

- As part of the second evacuation schedule initiated on April 16, 2020, more than 40,000 Turkish citizens were brought from 117 countries listed below to our homeland.

The United States, Afghanistan, Germany, Albania, Argentina, Australia, Austria, Azerbaijan, the Bahamas, Bahrain, Bangladesh, Barbados, Belgium,

## Evacuations Carried Out By The Republic of Turkey During Covid-19 Pandemic

United Arab Emirates, United Kingdom, Bolivia, Bosnia and Herzegovina, Brazil, Bulgaria, Burkina Faso, Algeria, Chad, Czechia, Djibouti, Dominican Republic, Denmark, Ecuador, Armenia, Estonia, Ethiopia, Morocco, Ivory Coast, the Philippines, Finland, France, Gambia, Ghana, Guinea, South Korea, Croatia, India, the Netherlands, Iraq, Iran, Ireland, Spain, Israel, Sweden, Switzerland, Italy, Cambodia, Canada, Montenegro, Qatar, Kazakhstan, Kenya, Kyrgyzstan, TRNC, Democratic Republic of the Congo, Kosovo, Costa Rica, Kuwait, North Macedonia, Cuba, Jamaica, Japan, Latvia, Liberia, Lithuania, Lebanon, Luxembourg, Hungary, Madagascar, Maldives, Malaysia, Mali, Malta, Colombia, Egypt, Mongolia, Moldova, Mauritania, Mozambique, Nepal, Niger, Nigeria, Norway, Uzbekistan, Pakistan, Paraguay, Peru, Poland, Portugal, Romania, Rwanda, Russian Federation, Senegal, Serbia, Sierra Leone, Singapore, Slovakia, Slovenia, Somalia, Sri Lanka, St. Vincent and the Grenadines, Sudan, Saudi Arabia, Chile, Tajikistan, Tanzania, Thailand, Ukraine, Oman, Uruguay, Jordan, Greece and Zambia

Turkey has been concerned with all its citizens through its representative offices abroad and meeting their needs throughout the pandemic.

Turkish citizens, who are unable to receive medical treatment abroad, are brought to Turkey by the ambulance aircraft of Turkey's Ministry of Health. Within this framework, a total of 64 Turkish citizens have been brought from 24 countries to Turkey via this method as of March 11.

Turkey is not only helping its own citizens with their evacuation, but also the evacuation of foreign nationals. In this context, 71 evacuation flights have been carried out and a total of 1,037 foreign nationals have been evacuated so far.

# Evacuations Carried Out By The Republic of Turkey During Covid-19 Pandemic

## LIST OF COUNTRIES FROM WHERE TURKISH CITIZENS HAVE RETURNED BY THEIR ORIGIN

Number	Country Name	Total	Number	Country Name	Total
1	TRNC	8,341	34	Sweden	317
2	Saudi Arabia	7,734	35	Belarus	311
3	Germany	5,531	36	Tanzania	286
4	Kuwait	3,753	37	Spain	272
5	Iraq	3,375	38	Oman	250
6	USA	2,944	39	Libya	247
7	Algeria	2,815	40	Greece	245
8	United Kingdom	2,424	41	India	193
9	France	1,934	42	Maldives	178
10	Netherlands	1,901	43	Jordan	174
11	Azerbaijan	1,838	44	Israel	171
12	Ukraine	1,818	45	Kenya	169
13	Canada	1,282	46	Portugal	166
14	Kazakhstan	1,154	47	Hungary	165
15	UAE	1,102	48	Bahrein	164
16	Qatar	1,094	49	Guinea	155
17	Uzbekistan	1,056	50	Pakistan	153
18	Russian Federation	959	51	Bangladesh	152
19	Montenegro	896	52	Afghanistan	146
20	Poland	740	53	Thailand	143
21	North Macedonia	719	54	Romania	142
22	Ethiopia	659	55	Moldova	139
23	Italy	646	56	Denmark	131
24	Iran	596	57	Dominican Republic	131
25	Ireland	510	58	Malta	129
26	Morocco	501	59	Australia	120
27	Sudan	463	60	Kosovo	118
28	Kyrgyzstan	454	61	Czech Republic	114
29	Belgium	450	62	Bulgaria	112
30	Austria	426	63	Niger	106
31	Switzerland	360	64	Djibouti	103
32	Serbia	350	65	Somalia	100

## Evacuations Carried Out By The Republic of Turkey During Covid-19 Pandemic

Number	Country Name	Total	Number	Country Name	Total
66	Tajikistan	98	98	South Korea	22
67	Liberia	97	99	Mozambique	21
68	Mauritania	92	100	Georgia	17
69	Ivory Coast	89	101	Slovenia	12
70	Croatia	88	102	St. Vincent and the Grenadines	12
71	Tunisia	87	103	Venezuela	12
72	Bosna and Herzegovina	85	104	Chad	11
73	Argentina	84	105	Latvia	11
74	Nigeria	80	106	Finland	10
75	Cameroon	75	107	Uruguay	10
76	Barbados	72	108	Cuba	9
77	Republic of South Africa	69	109	Mongolia	9
78	Luxembourg	62	110	Japan	8
79	Malesia	62	111	Nepal	8
80	Senegal	61	112	The Bahamas	7
81	Lebanon	50	113	Ecuador	6
82	Colombia	49	114	Costa Rica	6
83	Peru	47	115	Chile	5
84	Singapore	46	116	Armenia	4
85	Burkina Faso	44	117	Estonia	4
86	Mali	44	118	Cambodia	4
87	Ghana	43	119	Gambia	3
88	The Philippines	39	120	Jamaica	3
89	Mexico	39	121	Paraguay	3
90	Brazil	36	122	Cabo Verde	3
91	Slovakia	35	123	D. Republic of the Congo	2
92	Lithuania	34	124	Ruanda	2
93	Albania	33	125	Sierra Leone	2
94	People's Republic of China	32	126	Bolivia	1
95	Sri Lanka	32	127	Honduras	1
96	Madagascar	31	128	Zambia	1
97	Norway	30			

**GRAND TOTAL 66,753**



A dark blue world map with red circles of varying sizes overlaid on it. The circles are most concentrated in North America and Europe, with several large overlapping circles in the US and Europe. There are also smaller circles scattered across Asia, Africa, and Australia. A large red rectangular box is positioned in the center of the map, containing the title text.

## **INTERNATIONAL COMPARISON OF MEASURES**

# International Comparison of Measures

Turkey is one of the first countries to take measures for the fight against coronavirus. Turkey closely followed other countries' fight against coronavirus pandemic and started to take necessary measures even before there was a confirmed case in our country. Laying bare this fact, the tables below show the measures and when they were taken by countries as part of the fight against coronavirus. Turkey has taken into consideration all areas of social life while taking measures and has been among the leading countries that have taken swift action to slow down the spread of the pandemic. Under the leadership of President Erdoğan, Turkey has adopted every single measure taken by other countries as well as various others, which other countries have failed to implement or consider.

## QUESTION

◦ When was the first coronavirus case confirmed in different countries?

<b>TURKEY</b>	<b>11 March 2020</b> ◦
USA	20 January 2020
<b>GERMANY</b>	<b>27 January 2020</b>
BELGIUM	3 February 2020
<b>BRAZIL</b>	<b>25 February 2020</b>
CHINA	31 December 2019 ◦
<b>FRANCE</b>	<b>24 January 2020</b>
SOUTH KOREA	20 January 2020
<b>THE NETHERLANDS</b>	<b>27 February 2020</b>
UK	31 January 2020

First Case

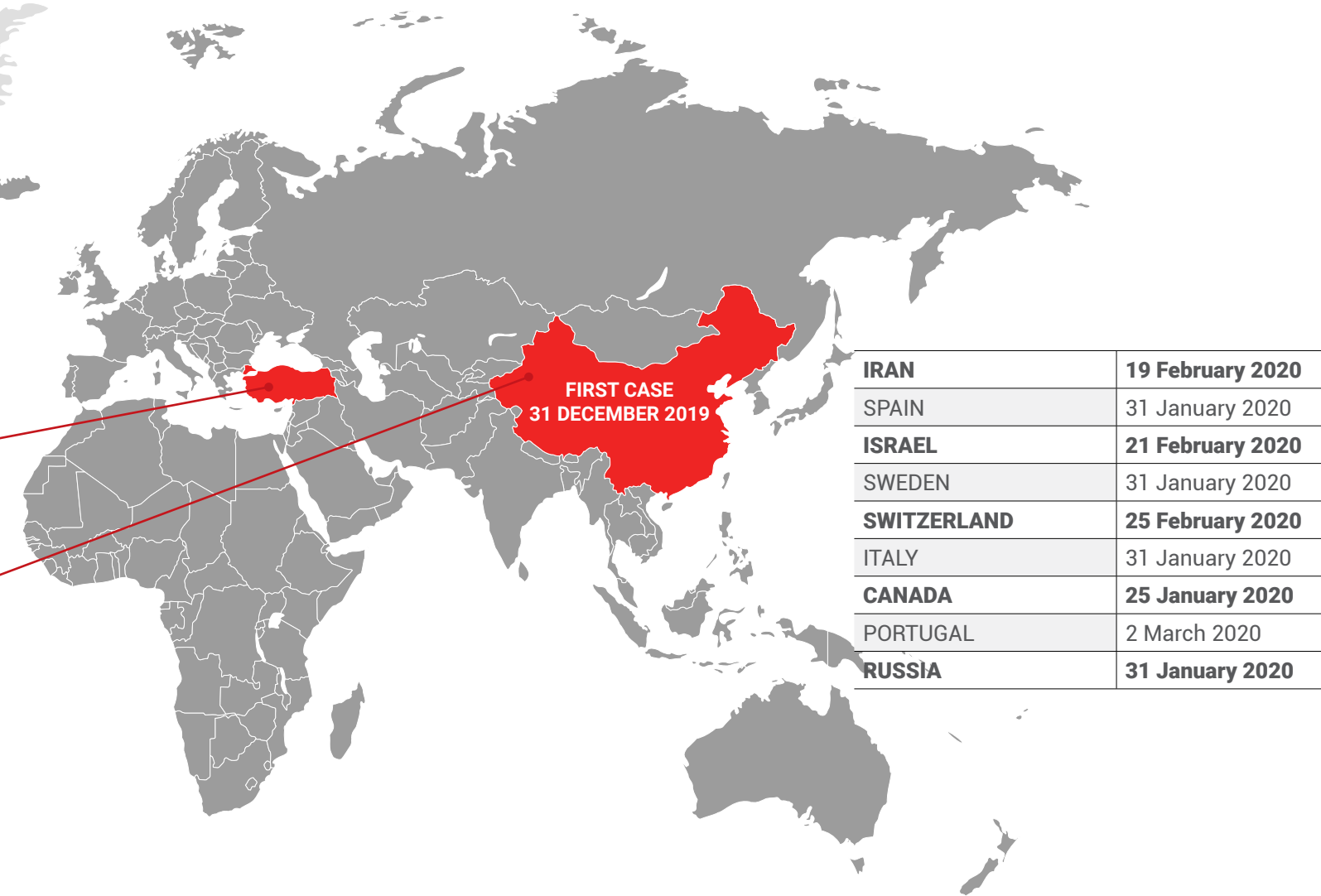

## International Comparison of Measures



# International Comparison of Measures



## Scientific Boards

QUESTION	Was a scientific board/advisory council set up in the country while managing the fight against coronavirus?	
 <b>TURKEY</b>	<p>"Coronavirus Scientific Board" was set up on January 10, 2020.</p>	
<b>USA</b>	<p>"Coronavirus Task Force" was created on January 29, 2020, with the participation of experts and senior officials of relevant authorities.</p>	
<b>GERMANY</b>	<p>Federal Ministry of the Interior and the Federal Ministry of Health set up a crisis desk on February 27, 2020, as provided in the pandemic plan of the Federal Government. The scientific views of experts from the Robert Koch Institute and the Department of Virology at Charite Hospital in Berlin are taken.</p>	
<b>BELGIUM</b>	<p>"The Scientific Committee for Coronavirus" has been working since January 2020.</p>	
<b>BRAZIL</b>	<p><b>No such board/council has been established.</b></p>	
<b>CHINA</b>	<p>"Central Leading Group on Responding to the Novel Coronavirus Disease Outbreak" was established on January 25, 2020.</p>	
<b>FRANCE</b>	<p>A board of experts was established in the process of combating coronavirus.</p>	
<b>SOUTH KOREA</b>	<p>Central Disaster and Safety Countermeasures Headquarters was established under the chairmanship of Prime Minister Chung Sye-kyun, comprising of the officials from relevant authorities such as the Ministry of Health and Welfare, KCDC (Korea Centers for Disease Control and Prevention) and the Ministry of Foreign Affairs.</p>	
<b>THE NETHERLANDS</b>	<p>Coordination is maintained by the National Institute for Public Health and the Environment (RIVM) in the Netherlands in the event of a pandemic. In this context, RIVM brings together "Outbreak Management Team", consisting of experts specialized on the pandemic disease from different disciplines, to analyze existing information and scientific data.</p>	

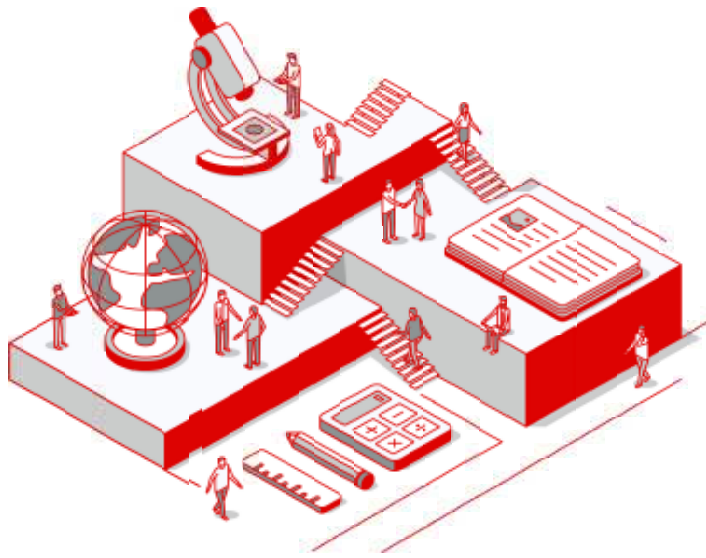

<b>UK</b>	The works are carried out under the umbrella of "The Cabinet Office Briefing Room" (COBR), which was created in 1972. Scientific Advisory Group for Emergencies (SAGE) continues its works under the COBR.
<b>IRAN</b>	A board was established during the fight against coronavirus.
<b>SPAIN</b>	There are "Coronavirus Technical Management Committee" and "Coronavirus Evaluation and Monitoring Committee" in Spain.
<b>ISRAEL</b>	<b>A board of doctors and various specialists was not established.</b> The process is managed by the government under the leadership of the Prime Minister, Ministry of Health, and relevant agencies.
<b>SWEDEN</b>	Public Health Agency of Sweden steers the process and makes recommendations through a group of experts including state epidemiologists.
<b>SWITZERLAND</b>	"The Swiss National Covid-19 Science Task Force" was set up on March 31, 2020.
<b>ITALY</b>	"Scientific Technical Committee" consisting of specialists was established and the Prime Minister attends its meetings from time to time.
<b>CANADA</b>	The first meeting of the Incident Response Group was held on January 27 with the participation of Prime Minister Trudeau. On March 4, a cabinet committee was also established to fight against Covid-19.
<b>PORTUGAL</b>	A task force comprising of specialists and those working with the Medical Board was established.
<b>RUSSIA</b>	"Coronavirus Prevention Center" was created on January 27, 2020. Under the chairmanship of the Prime Minister, "Coordination Council to Control the Incidence of Novel Coronavirus" was created on March 14, 2020.

# International Comparison of Measures



## Curfew

QUESTION	How many days after the first confirmed case did countries impose a partial lockdown or a curfew?
 <b>TURKEY</b>	<p>On March 22, 2020, <b>11 days after</b> the first confirmed case, a lockdown was imposed for those aged 65 and over and those with chronic illnesses. As of April 3, the lockdown included the citizens under 20.</p> <p>On April 10, 2020, a curfew was announced for 2 days for all citizens living in 30 metropolitan cities as well as Zonguldak.</p>
<b>USA</b>	<p>States decide on partial lockdowns in the USA. The first lockdown decision was made by the state of California on March 19, 2020. Measures are now being taken in Washington DC and 43 states for staying at home.</p>
<b>GERMANY</b>	<p>Lockdown was first imposed in the state of Bavaria 53 days (21.03.2020) after the first confirmed case, and partial lockdown across Germany was imposed <b>55 days after</b> (23.03.2020) the first confirmed case.</p>
<b>BELGIUM</b>	<p><b>44 days after</b> the first confirmed case, a partial lockdown was imposed on Wednesday, March 18, starting at 12.00 hours. It was extended until April 19.</p>
<b>BRAZIL</b>	<p><b>A curfew was not imposed.</b></p>
<b>CHINA</b>	<p>Quarantine took effect on January 23, 2020, in Hubei province and its capital Wuhan, where the pandemic broke out. Although there is no official quarantine enforced for the rest of the People's Republic of China (PRC), people have been encouraged to stay at home.</p>
<b>FRANCE</b>	<p>A lockdown/curfew was imposed <b>53 days after</b> the first confirmed case.</p>
<b>SOUTH KOREA</b>	<p><b>A lockdown or a curfew was not imposed.</b></p>

THE NETHERLANDS	A curfew was not imposed in the Netherlands.
UK	A lockdown was imposed on March 23, 2020, and people were restricted from going out unless it is essential, except for shopping for food, healthcare services, and short daily exercises.
IRAN	A partial lockdown or a curfew was not imposed in Iran.
SPAIN	A lockdown/curfew was imposed <b>43 days after</b> the first confirmed case.
ISRAEL	On March 17, 2020, <b>25 days after</b> the first confirmed case, a partial lockdown was imposed.
SWEDEN	A partial lockdown or curfew was not imposed.
SWITZERLAND	A partial or a full lockdown was not imposed in Switzerland.
ITALY	A curfew was imposed across the country <b>19 days after</b> the first confirmed case.
CANADA	A curfew was not imposed by federal authorities.
PORTUGAL	It was recommended not to go out unless it is essential as per the state of emergency declared on March 18, <b>16 days after</b> the first confirmed case.
RUSSIA	A lockdown was imposed <b>57 days after</b> the first confirmed case (as of March 28, 2020) on those who were not obliged to go to work and <b>52 days after</b> (as of March 23) on those over the age of 65.

# International Comparison of Measures



## Suspension of Schools

QUESTION	How many days after the first confirmed coronavirus case did countries suspend schools?	
 <b>TURKEY</b>	On March 12, 2020, only <b>1 day after</b> the first confirmed case, it was decided to suspend schools.	
<b>USA</b>	Decisions to suspend schools are taken by state governors. The first decision was taken on March 12, 2020, in Ohio. It was decided to suspend schools in 15 states until the end of the academic year.	
<b>GERMANY</b>	On March 16, 2020, <b>19 days after</b> the first confirmed case, it was decided to shut down all schools and daycare centers in the states of Saarland and Bavaria. Schools and daycare centers were shut down across Germany on March 23, 2020, <b>55 days after</b> the first confirmed case.	
<b>BELGIUM</b>	Decisions including the measure to suspend education at schools were made <b>40 days after</b> the first confirmed case, taking effect on March 4, 2020.	
<b>BRAZIL</b>	This decision was taken for the capital Brasília <b>15 days after</b> the first confirmed case. Other states declared this decision later on.	
<b>CHINA</b>	On January 21, 2020, the current holiday was extended and the return to school was postponed. On January 29, 2020, the Chinese Ministry of Education announced that all schools across the country, including universities, would remain shut down until further notice.	
<b>FRANCE</b>	Schools were suspended <b>52 days after</b> the first confirmed case.	
<b>SOUTH KOREA</b>	On February 23, 2020, <b>34 days after</b> the first confirmed case, it was announced that the start of schools, which was scheduled for March 2, had been postponed.	
<b>THE NETHERLANDS</b>	All schools, kindergartens, and daycare centers were suspended <b>17 days after</b> (as of March 16, 2020) the first confirmed case.	



<b>UK</b>	Schools were suspended on March 20, 2020, <b>50 days after</b> the first confirmed case.
<b>IRAN</b>	Schools were suspended <b>6 days after</b> the first confirmed case.
<b>SPAIN</b>	Some Autonomies Communities suspended schools <b>38 days after</b> the first confirmed case. Schools were suspended across the country <b>43 days after</b> the first confirmed case.
<b>ISRAEL</b>	Schools were suspended on March 13, 2020, 21 days after the first confirmed case.
<b>SWEDEN</b>	Preschools and elementary schools are mainly open. Principals/municipalities were authorized to suspend elementary schools on March 1, 2020, <b>30 days after</b> the first confirmed case. High schools, vocational schools, colleges, and universities were shut down, and they started distance education <b>46 days after</b> the first confirmed case.
<b>SWITZERLAND</b>	Schools were suspended on March 13, 2020, <b>17 days after</b> the first confirmed case.
<b>ITALY</b>	Schools were suspended across the country <b>13 days after</b> the first confirmed case.
<b>CANADA</b>	The decision to suspend schools is taken by states. States suspended schools on different dates.
<b>PORTUGAL</b>	On March 18, 2020, <b>16 days after</b> the first confirmed case, schools were suspended by the state of emergency declared.
<b>RUSSIA</b>	Schools were suspended on March 23, 2020, <b>52 days after</b> the first confirmed case

# International Comparison of Measures



Distance Learning

## QUESTION

Did countries introduce distance learning?



<b>TURKEY</b>	On March 12, 2020, only <b>1 day after</b> the first confirmed case, it was decided to introduce distance learning, and it started on March 23, 2020.
<b>USA</b>	Schools introduced distance learning.
<b>GERMANY</b>	A consistent distance learning scheme was not created. Teachers continue their courses by means of giving assignments to their students over the internet.
<b>BELGIUM</b>	There is no infrastructure for distance learning at primary schools and high schools in Belgium. Universities started distance learning as of March 16, 2020.
<b>BRAZIL</b>	Distance learning was introduced to some extent.
<b>CHINA</b>	Distance learning was introduced.
<b>FRANCE</b>	Distance learning was introduced.
<b>SOUTH KOREA</b>	Distance learning was introduced.
<b>THE NETHERLANDS</b>	Courses are offered "on-line".
<b>UK</b>	Distance learning was not introduced for primary and secondary schools. A significant part of independent universities offers distance learning.
<b>IRAN</b>	Distance learning was introduced.
<b>SPAIN</b>	Distance learning was introduced.



<b>ISRAEL</b>	Distance learning was introduced.
<b>SWEDEN</b>	Preschools and primary schools are open. High schools, colleges, and universities introduced distance learning <b>46 days after</b> the first confirmed case.
<b>SWITZERLAND</b>	Education was suspended across the country on March 13, 2020. 26 cantons of Switzerland introduced different practices in education during the school closure. <b>There is no consistent practice adopted nationwide.</b>
<b>ITALY</b>	Distance learning was introduced.
<b>CANADA</b>	On March 13, 2020, <b>48 days after</b> the first confirmed case, distance learning was introduced in the state of Ontario.
<b>PORTUGAL</b>	All schools introduced distance learning.
<b>RUSSIA</b>	All units were allowed to introduce distance learning on their own initiative <b>45 days after</b> the first confirmed case (as of March 16, 2020). The distance online learning platform was introduced <b>67 days after</b> the first confirmed case (as of April 7, 2020).

## International Comparison of Measures



### Use of Libraries

QUESTION	How many days after the first confirmed case did countries prohibit the use of all kinds of libraries?
 <b>TURKEY</b>	On March 15, 2020, <b>4 days after</b> the first confirmed case, it was decided to shut down libraries.
<b>USA</b>	Libraries are shut down in accordance with stay-at-home orders made in the states they are based. There is no general practice.
<b>GERMANY</b>	Libraries were shut down <b>55 days after</b> the first confirmed case (March 23, 2020).
<b>BELGIUM</b>	Libraries were shut down <b>40 days after</b> the first confirmed case (March 14, 2020).
<b>BRAZIL</b>	Libraries were shut down <b>15 days after</b> the first confirmed case in the capital Brasília. Other states announced the shutdown of libraries later on.
<b>CHINA</b>	On January 25, 2020, the National Health Commission of the PRC introduced rules and restrictions on the use of public spaces and public transportation nationwide. The said spaces were subjected to gradually extending measures in parallel to the spread of the pandemic.
<b>FRANCE</b>	Libraries were shut down <b>50 days after</b> the first confirmed case.
<b>SOUTH KOREA</b>	On February 25, 2020, <b>36 days after</b> the first confirmed case, it was announced that public libraries would be temporarily shut down.
<b>THE NETHERLANDS</b>	Libraries were shut down <b>13 days after</b> the first confirmed case (as of March 12, 2020) as part of the measures announced.
<b>UK</b>	Libraries were shut down on March 23, 2020, <b>53 days after</b> the first confirmed case.
<b>IRAN</b>	Libraries were shut down <b>4 days after</b> the first confirmed case.



<b>SPAIN</b>	Libraries were shut down <b>43 days after</b> the first confirmed case.
<b>ISRAEL</b>	Libraries were shut down on March 17, 2020, <b>25 days after</b> the first confirmed case.
<b>SWEDEN</b>	<b>Libraries were not shut down.</b>
<b>SWITZERLAND</b>	Libraries were shut down on March 16, 2020, <b>20 days after</b> the first confirmed case.
<b>ITALY</b>	Libraries were shut down nationwide <b>17 days after</b> the first confirmed case.
<b>CANADA</b>	All service points of Libraries and Archives Canada were shut down as of March 16, 2020, <b>51 days after</b> the first confirmed case,
<b>PORTUGAL</b>	Libraries were shut down by the state of emergency declared on March 18, 2020, <b>16 days after</b> the first confirmed case.
<b>RUSSIA</b>	Libraries were shut down as of March 18, 2020, <b>47 days after</b> the first confirmed case.

# International Comparison of Measures



## International Flight Ban

QUESTION	How many days after the first confirmed case did countries decide to restrict/ban international flights?	
 <b>TURKEY</b>	Although the first case was confirmed on March 11 in Turkey, flights were suspended much earlier than this date (February 29, 2020) to countries such as China, Iran, and Italy. On March 12 and 13, the scope of the international flight ban was extended. On March 21, the number of countries to which the flights were banned reached 68.	
<b>USA</b>	Travel to China was restricted <b>4 days after</b> the first confirmed case (who was found to have travelled to Wuhan). The said travel restriction was later extended to include Iran, Schengen Area, United Kingdom, and Ireland.	
<b>GERMANY</b>	There was no international flight restriction/ban. However, there are some countries to which the flights are suspended due to the effects of the pandemic in these countries. In this context, flights to Germany from Iran and China were banned <b>48 days after</b> (16.03.2020) the first confirmed case.	
<b>BELGIUM</b>	All international travels, if not essential, were prohibited <b>44 days after</b> the first confirmed case, taking effect as of March 18, 2020, at 12.00 hours.	
<b>BRAZIL</b>	The entry of foreigners from certain countries into Brazil was banned <b>27 days after</b> the first confirmed case.	
<b>CHINA</b>	The first restriction was adopted on January 23, 2020, when the quarantine enforced in Wuhan extended to include international flights. As of March 29, 2020, all international flights between China and other countries were restricted to one flight per week for each airline.	
<b>FRANCE</b>	EU and Schengen borders were closed <b>53 days after</b> the first confirmed case.	
<b>SOUTH KOREA</b>	Flights to China were temporarily suspended as of January 24, <b>4 days after</b> the first confirmed case.	
<b>THE NETHERLANDS</b>	Those with critical occupations, particularly healthcare professionals, were asked not to leave the country <b>13 days after</b> the first confirmed case (as of March 12, 2020).	



UK	No flight restriction/ban was imposed in the United Kingdom.
IRAN	No international flight restriction or ban was imposed in Iran.
SPAIN	Flights to China were suspended in early February. This was followed by a flight ban to Italy <b>39 days after</b> the first confirmed case.
ISRAEL	No restriction or ban was imposed on Israeli citizens for leaving the country except for civil servants and members of the army.
SWEDEN	All flights to the PRC were suspended when the first case was confirmed (January 31). Flights to and from Iran were suspended on March 2, 2020 ( <b>31 days after the first confirmed case</b> ). Besides, there is a travel restriction to the EU that was introduced on March 17, 2020 ( <b>46 days after</b> the first confirmed case).
SWITZERLAND	The first restriction was imposed on Italy, France, Germany, Austria, Spain, and non-EU/non-EFTA countries on March 19, 2020, <b>23 days after</b> the first confirmed case. A general travel ban was introduced to include Schengen countries on March 26, 2020, <b>30 days after</b> the first confirmed case.
ITALY	All flights to and from the PRC were suspended on January 31, 2020, when the first case was confirmed. Other countries suspended their flights to Italy as it became the epicenter of the pandemic in the following period.
CANADA	It was recommended not to travel abroad, unless it is essential, on March 13, 2020 ( <b>on the 48th day since the confirmation of the first case</b> ), and the Canadians abroad were urged to return to the country.
PORTUGAL	Flights to and from non-EU countries were suspended for 30 days in line with the European Council decision and the state of emergency declared on March 18, 2020. It was announced that an exception would be made for Venezuela, USA, Canada, South Africa, and members of the Community of Portuguese Language Countries (CPLP), which are mostly populated by Portuguese
RUSSIA	Chinese flights were suspended <b>1 day after</b> the first confirmed case. All international flights were suspended as of March 27, 2020, <b>56 days after</b> the first confirmed case.

## International Comparison of Measures



### Inter-city Travel Ban

QUESTION	How many days after the first confirmed case did countries impose an inter-city travel (domestic travel) ban/restriction?
 TURKEY	On March 28, 2020, only <b>17 days after</b> the first confirmed case, inter-city bus services were restricted.
USA	There is no domestic travel ban.
GERMANY	A general inter-city travel (domestic travel) ban/restriction was not imposed. There may be differences in practices among states. For instance, only the residents of the state of Mecklenburg-Vorpommern are allowed into the state in their cars.
BELGIUM	Domestic travel was restricted on March 18, 2020, <b>44 days after</b> the first confirmed case.
BRAZIL	Inter-city bus travel was banned in the state of Rio de Janeiro <b>21 days after</b> the first confirmed case.
CHINA	Restrictions were introduced on January 23, 2020, with the quarantine in Wuhan. Neighboring cities were placed in quarantine gradually a short while later, and the entire Hubei province was included in the quarantine before long. Domestic bus and train services, especially between states, were largely suspended during the spread of the pandemic.
FRANCE	A restriction/ban was imposed on domestic travel <b>53 days after</b> the first confirmed case.
SOUTH KOREA	Inter-city travel ban/restriction was not imposed.
THE NETHERLANDS	A domestic travel ban was not imposed.
UK	No inter-city travel ban was imposed.
IRAN	Travel between provinces was banned <b>35 days after</b> the first confirmed case.

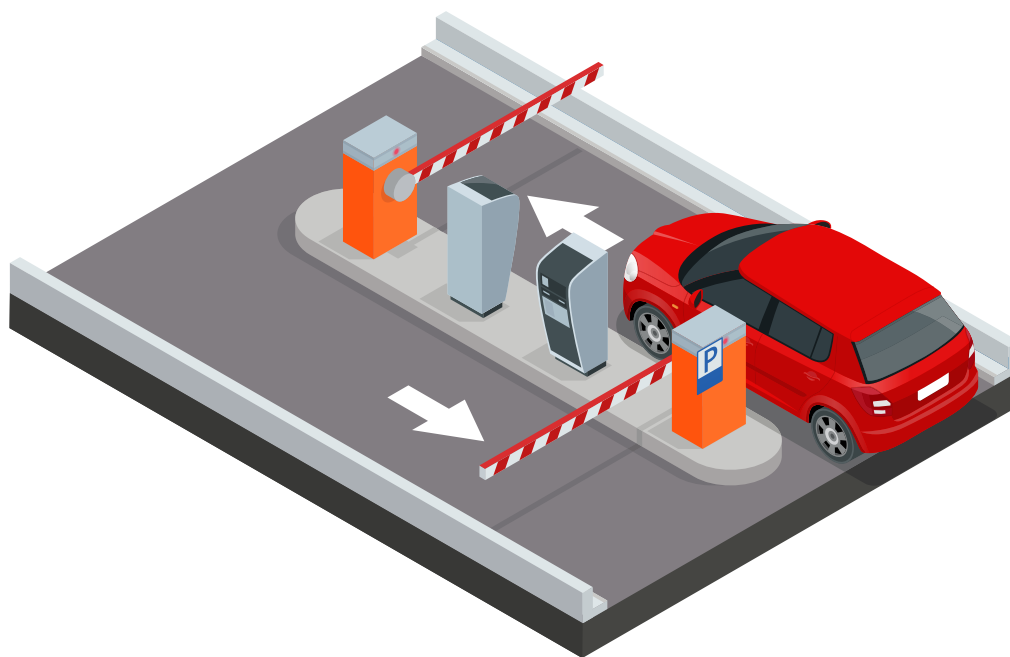

<b>SPAIN</b>	Domestic travel restriction was imposed <b>43 days after</b> the first confirmed.
<b>ISRAEL</b>	Due to Passover, the inter-city travel ban was temporarily imposed between April 7 at 19:00 hours and April 10 at 06:00 hours. No such ban was imposed other than the given dates.
<b>SWEDEN</b>	<b>No ban/restriction was imposed on inter-city travel (domestic travel).</b>
<b>SWITZERLAND</b>	<b>No inter-city travel ban/restriction was imposed in Switzerland, which was effective nationwide.</b>
<b>ITALY</b>	The inter-city travel ban was imposed nationwide <b>19 days after</b> the first confirmed case.
<b>CANADA</b>	Restrictions on bus travels and measures regarding intra-state travel are imposed by local authorities based on regional requirements.
<b>PORTUGAL</b>	Travel restriction was imposed through the state of emergency declared on March 18, 2020, <b>16 days after</b> the first confirmed case.
<b>RUSSIA</b>	<b>No inter-city travel ban was imposed nationwide.</b>

## International Comparison of Measures



### Public Transport Ban

QUESTION	How many days after the first confirmed case did countries introduce arrangements on the use of public transport vehicles (spaced seating/ use of masks)?
 <b>TURKEY</b>	Arrangements on the use of public transport vehicles were introduced on March 24, 2020, <b>13 days after</b> the first confirmed case.
<b>USA</b>	A general arrangement on the use of public transport vehicles was not introduced.
<b>GERMANY</b>	Spaced seating arrangement was introduced for buses on March 23, 2020, <b>55 days after</b> the first confirmed case.
<b>BELGIUM</b>	<b>44 days after</b> the first confirmed case.
<b>BRAZIL</b>	An arrangement on public transportation was introduced <b>21 days after</b> the first confirmed case. Passenger capacity was reduced by 50% for the state of Rio de Janeiro. Other states announced such arrangements later on.
<b>CHINA</b>	On January 25, 2020, the National Health Commission of the PRC introduced rules and restrictions on the use of public spaces and public transportation nationwide. Additional measures such as restrictions on passenger numbers, mask obligations, and the recent practice of green QR code was introduced gradually.
<b>FRANCE</b>	An arrangement for the use of public transport vehicles was not introduced.
<b>SOUTH KOREA</b>	Spaced seating arrangement has been followed in public transportation since late February.
<b>THE NETHERLANDS</b>	It was decided to restrict the number of drivers of the public transport vehicles and to follow the rule of 1.5 meters of distance as of March 23, 2020, <b>24 days after</b> the first confirmed case.
<b>UK</b>	An arrangement for the use of public transport vehicles was not introduced.
<b>IRAN</b>	Travel between provinces was banned <b>35 days after</b> the first confirmed case.

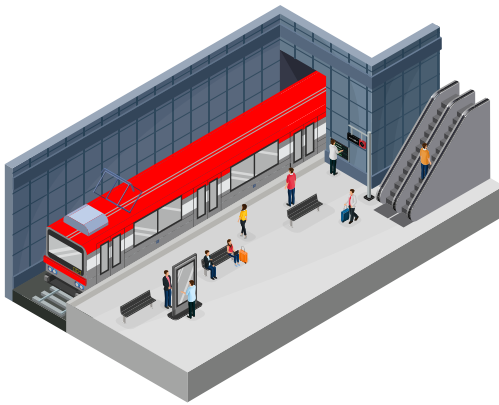

<p><b>SPAIN</b></p>	<p>Announcements are made to follow a well-spaced waiting and seating arrangement while travelling on the metro. It was laid down that the buses must carry maximum one-third of their passenger capacity for intracity public transportation. It was decided to reduce the passenger capacity to the limited number allowed on public holidays.</p>
<p><b>ISRAEL</b></p>	<p>An arrangement was made on the use of public transport vehicles on March 9, 2020, <b>17 days after</b> the first confirmed case.</p>
<p><b>SWEDEN</b></p>	<p>It was decided that passengers should not board public transport buses from the front door and that a tape barrier was set up between the driver seat and passengers to stop them from swiping their tickets on March 17, 2020, <b>46 days after</b> the first confirmed case.</p>
<p><b>SWITZERLAND</b></p>	<p><b>A nationwide well-spaced seating arrangement and similar other practices were not introduced for public transport vehicles in Switzerland.</b></p>
<p><b>ITALY</b></p>	<p><b>29 days after</b> the first confirmed case, passengers of public transport vehicles were obliged to keep a safe distance of one meter between the driver and themselves. If this is not possible, they are obliged to wear protective masks. Disinfection of public transport vehicles has become compulsory and they are obliged to provide hand disinfectants for their passengers.</p>
<p><b>CANADA</b></p>	<p>Restrictions were imposed in the state of Ontario on March 13, 2020, <b>48 days after</b> the first confirmed case.</p>
<p><b>PORTUGAL</b></p>	<p>Special hygiene rules were introduced for public transport vehicles on March 2, 2020, when the first case was confirmed. Other arrangements (such as spaced seating, air circulation, etc.) were made on March 22. It was decided to place screens between drivers and passengers on April 7, 2020.</p>
<p><b>RUSSIA</b></p>	<p>Decisions on public transportation were taken on February 26, 2020, <b>26 days after</b> the first confirmed case.</p>

# International Comparison of Measures



## International Travel Ban for Civil Servants

QUESTION	How many days after the first confirmed case did countries impose international travel restriction/ban on civil servants?
 <b>TURKEY</b>	On March 12, 2020, only <b>1 day after</b> the first confirmed case, international travel restriction was imposed on civil servants.
<b>USA</b>	Non-essential international travels were suspended on March 12, 2020.
<b>GERMANY</b>	An exclusive international travel restriction/ban on civil servants was not imposed.
<b>BELGIUM</b>	Such an arrangement was introduced on March 18, 2020, <b>44 days after</b> the first confirmed case.
<b>BRAZIL</b>	Such an arrangement was introduced <b>21 days after</b> the first confirmed case.
<b>CHINA</b>	On January 29, 2020, the National Immigration Administration of China announced its recommendation for citizens to avoid travelling abroad as part of the fight against the coronavirus. Civil servants were also subjected to these restrictions.
<b>FRANCE</b>	There is no information about any international travel restriction/ban imposed on civil servants.
<b>SOUTH KOREA</b>	There is no information about any international travel restriction/ban imposed on civil servants.
<b>THE NETHERLANDS</b>	An exclusive international travel restriction/ban on civil servants was not imposed.
<b>UK</b>	An exclusive international travel restriction/ban on civil servants was not imposed.
<b>IRAN</b>	International travel restriction was imposed on civil servants <b>14 days after</b> the first confirmed case.

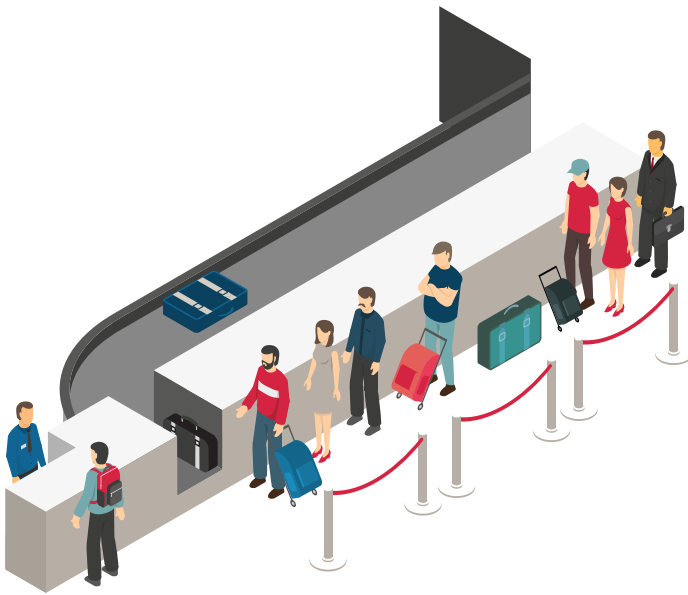

<b>SPAIN</b>	An exclusive international travel restriction/ban on civil servants was not imposed.
<b>ISRAEL</b>	An international travel ban was imposed on all civil servants and members of the army on March 4, 2020 ( <b>12 days after the first confirmed case</b> ).
<b>SWEDEN</b>	An international travel restriction/ban on civil servants was not imposed.
<b>SWITZERLAND</b>	An exclusive international travel restriction/ban on civil servants was not imposed.
<b>ITALY</b>	An international travel restriction/ban on civil servants was not imposed. Besides, international travel is limited as many countries have suspended flights to Italy.
<b>CANADA</b>	Defense Staff announced on March 13, 2020, ( <b>on the 48th day of the pandemic</b> ) that international travels of all military personnel were banned. There was no special restriction for the remaining federal civil servants except for a general travel warning.
<b>PORTUGAL</b>	It was determined that only essential international travels were allowed by the declaration of the state of emergency on March 18, 2020, <b>16 days after</b> the first confirmed case.
<b>RUSSIA</b>	Such a restriction/ban was imposed on March 11, 2020, <b>40 days after</b> the first confirmed case.

# International Comparison of Measures



## Arrangements for Taxis

QUESTION	How many days after the first confirmed case did countries introduce arrangements/decisions on taxis?
 <b>TURKEY</b>	On March 30, 2020, <b>19 days after</b> the first confirmed case, a decision on taxis was taken.
<b>USA</b>	A special arrangement was not introduced for taxis.
<b>GERMANY</b>	A special arrangement was not introduced for taxis.
<b>BELGIUM</b>	<b>44 days after</b> the first confirmed case.
<b>BRAZIL</b>	A special arrangement was not introduced for taxis.
<b>CHINA</b>	On January 25, 2020, the National Health Commission of the PRC introduced rules and restrictions on the use of public spaces and public transportation nationwide. Special measures on taxis (placing a plastic sheet between the driver and passenger) were introduced gradually.
<b>FRANCE</b>	A special arrangement was not introduced for taxis.
<b>SOUTH KOREA</b>	A special arrangement was not introduced for taxi drivers.
<b>THE NETHERLANDS</b>	On April 8, 2020, <b>40 days after</b> the first confirmed case, it was decided to support taxi drivers as well.
<b>UK</b>	A special arrangement was not introduced for taxis.
<b>IRAN</b>	<b>4 days after</b> the first confirmed case, practices such as disinfection of taxis and cessation of cash use were introduced. On the other hand, <b>7 weeks after</b> the first confirmed case, the arrangement allowing only 2 passengers on the backseat of taxis was introduced in Tehran.
<b>SPAIN</b>	A special arrangement was not introduced for taxis.



<b>ISRAEL</b>	On March 25, 2020, <b>33 days after</b> the first confirmed case, an arrangement was introduced for taxis.
<b>SWEDEN</b>	A special arrangement was not introduced for taxis.
<b>SWITZERLAND</b>	A special arrangement was not introduced for taxis.
<b>ITALY</b>	<b>29 days after</b> the first confirmed case, it was made obligatory to leave front passenger seat empty in commercial taxis and rental cars, to carry two passengers on the backseat. Mask use by the drivers was made obligatory.
<b>CANADA</b>	A special arrangement was not introduced for taxis.
<b>PORTUGAL</b>	A special arrangement was not introduced for taxis other than those for public transport vehicles.
<b>RUSSIA</b>	A special arrangement was not introduced for taxis.

# International Comparison of Measures



## Measures on Flexible Working

<b>QUESTION</b>	<b>How many days after the first confirmed case did countries introduce flexible working methods (home/remote working or work in rotations) in the public sector?</b>
 <b>TURKEY</b>	On March 22, 2020, <b>11 days after</b> the first confirmed case, flexible working methods were introduced.
<b>USA</b>	Following the President's Coronavirus Guidelines issued by the White House on March 16, 2020, flexible working methods were gradually introduced for civil servants.
<b>GERMANY</b>	<b>There is no consistent practice in the public sector.</b> Those who can work from home can continue to work in their residences.
<b>BELGIUM</b>	Decisions including the measure to follow the principle of working from home, unless it is essential to go to work, were taken <b>40 days after</b> the first confirmed case, taking effect from March 14, 2020.
<b>BRAZIL</b>	Decisions on flexible working methods were made <b>21 days after</b> the first confirmed case.
<b>CHINA</b>	Following the end of the New Year Holiday on February 3, 2020, China introduced such working schemes for public institutions despite various practices among them.
<b>FRANCE</b>	Decisions regulating working principles were introduced <b>53 days after</b> the first confirmed case.
<b>SOUTH KOREA</b>	Guidelines on flexible working hours for civil servants and the minimization of face-to-face meetings and business travels were announced on March 22, <b>60 days after</b> the first confirmed case.
<b>THE NETHERLANDS</b>	On March 12, 2020, <b>13 days after</b> the first confirmed case, flexible working methods (home/remote working or work in rotation) were introduced.



<b>UK</b>	There is no general practice with an exact date, and it is observed that public institutions have gradually introduced work in rotations or from home through administrative arrangements since the first confirmed cases.
<b>IRAN</b>	The working hours of civil servants were reduced 10 days after the first confirmed case, and a flexible working scheme was introduced for public institutions <b>34 days after</b> the first confirmed case.
<b>SPAIN</b>	A decision regarding flexible working methods was made <b>43 days after</b> the first confirmed case.
<b>ISRAEL</b>	Flexible working methods were introduced on March 16, 2020, <b>24 days after</b> the first confirmed case.
<b>SWEDEN</b>	Public Health Agency of Sweden began sharing its recommendations as to 'work from home' especially for Stockholm and the surrounding area on March 16, 2020, <b>45 days after</b> the first confirmed case.
<b>SWITZERLAND</b>	There are flexible working methods available for the public sector in the Swiss legislation. Within this context, no additional regulation was required on this matter. It was put into practice under the responsibility of unit managers.
<b>ITALY</b>	Flexible work practices were determined <b>13 days after</b> the first confirmed case.
<b>CANADA</b>	As of March 16, 2020, on the <b>51<sup>st</sup> day</b> of the pandemic, federal civil servants started to work from home/in rotations.
<b>PORTUGAL</b>	On March 20, 2020, the <b>18<sup>th</sup> day</b> of the pandemic, it was announced that all public servants should work from home via phone or internet within the bounds of possibility.
<b>RUSSIA</b>	Flexible work arrangements were announced as of March 16, 2020, <b>46 days after</b> the first confirmed case.

# International Comparison of Measures



## Measures for Recreational Areas

<b>QUESTION</b>	<b>How many days after the first confirmed case did countries decide to stop the activities of entertainment venues and recreational areas (cafes, restaurants, bars, clubs, cinemas, etc.)?</b>
 <b>TURKEY</b>	On March 16, 2020, only <b>5 days after</b> the first confirmed case, a relevant decision was taken.
<b>USA</b>	The decision to stop the activities of these businesses is made by the states. Washington D.C. and 48 states have already decided accordingly.
<b>GERMANY</b>	The said decision was made on March 23, 2020, <b>55 days after</b> the first confirmed case.
<b>BELGIUM</b>	Decisions were made <b>40 days after</b> the first confirmed case, taking effect from March 14, 2020.
<b>BRAZIL</b>	The relevant decision was made for businesses such as cafes, restaurants, etc. for the capital Brasília <b>23 days after</b> the first confirmed case, and <b>19 days after</b> the first confirmed case for cinemas. Other provinces announced the decision later on.
<b>CHINA</b>	On January 25, 2020, the National Health Commission of the PRC introduced rules and restrictions on the use of public areas nationwide. In the forthcoming period, entertainment venues and recreational areas especially in metropolitan cities could be opened with special permits and provided that the rules such as social distancing and mask use were followed.
<b>FRANCE</b>	Decisions on entertainment venues and recreational areas were made <b>50 days after</b> the first confirmed case.
<b>SOUTH KOREA</b>	<b>Entertainment venues and recreational areas were not shut down.</b> However, bars and nightclubs in Seoul were shut down between April 8 and 19.
<b>THE NETHERLANDS</b>	On March 15, 2020, <b>16 days after</b> the first confirmed case, it was decided to suspend the activities of restaurants, bars, and similar businesses, and sports clubs.
<b>UK</b>	On March 23, 2020, <b>50 days after</b> the first confirmed case, non-essential businesses or enterprises, where people came together, were shut down.



<b>IRAN</b>	Cultural activities such as theatres, concerts, and cinemas were suspended <b>5 days after</b> the first confirmed case.
<b>SPAIN</b>	The decision on cultural activities such as cinemas, theatres, etc., where people gather, was made <b>38 days after</b> the first confirmed case, whereas the decision on restaurants and cafes was made <b>43 days after</b> the first confirmed case.
<b>ISRAEL</b>	On March 16, 2020, <b>24 days after</b> the first confirmed case, arrangements for entertainment venues and recreational areas were made.
<b>SWEDEN</b>	<b>No decision was made to shut down the said businesses.</b>
<b>SWITZERLAND</b>	An arrangement was made on April 19, 2020, <b>54 days after</b> the first confirmed case.
<b>ITALY</b>	Decisions on the activities of these businesses were adopted nationwide <b>18 days after</b> the first confirmed case.
<b>CANADA</b>	Measures were taken on March 17, 2020 ( <b>52<sup>nd</sup> day of the pandemic</b> ) in the province of Ontario, on March 18, 2020 ( <b>50<sup>th</sup> day of the pandemic</b> ) in the province of British Columbia, on March 22, 2020 ( <b>24<sup>th</sup> day of the pandemic</b> ) in the province of Quebec.
<b>PORTUGAL</b>	All commercial enterprises serving the public were shut down <b>18 days after</b> the first confirmed case except for bakeries, supermarkets, gas stations, pharmacies, kiosks, etc. that provide services for the maintenance of life.
<b>RUSSIA</b>	As of March 24, 2020, <b>53 days after</b> the first confirmed case, decisions were made on the said fields of activity.

# International Comparison of Measures



## Measures for Entertainment Venues

QUESTION	How many days after the first confirmed case did countries suspend social, cultural, artistic, and academic events?
 <b>TURKEY</b>	On March 12, 2020, <b>1 day after</b> the first confirmed case, the said events were suspended.
<b>USA</b>	The said events were suspended following the President's Guidelines issued by the White House on March 16, 2020.
<b>GERMANY</b>	On March 23, 2020, <b>55 days after</b> the first confirmed case, a decision was made concerning these events.
<b>BELGIUM</b>	These events were suspended with effect from March 14, 2020, <b>40 days after</b> the first confirmed case.
<b>BRAZIL</b>	These events were stopped for the capital Brasília <b>19 days after</b> the first confirmed case. Other states announced their decision to suspend these events later.
<b>CHINA</b>	With the spread of the pandemic, such events were cancelled/postponed one after another throughout the country. However, no special decision was made to not stage these events and it was considered within the scope of suspension of events involving gatherings.
<b>FRANCE</b>	Such events were suspended <b>50 days after</b> the first confirmed case.
<b>SOUTH KOREA</b>	South Korea started to cancel social, cultural, artistic, and academic events rapidly from February 18, 2020, when the pandemic began to spread across the country.
<b>THE NETHERLANDS</b>	As of March 12, 2020, <b>13 days after</b> the first confirmed case, restrictions were introduced on meetings held with the participation of more than 100 people, and museums, concert areas, theatres, sports clubs were shut down and events were cancelled within this framework.



UK	Mass events were completely suspended <b>50 days after</b> the first confirmed case.
IRAN	Social, cultural, artistic, and academic events were suspended <b>5 days after</b> the first confirmed case.
SPAIN	In some Autonomous Communities, these events were suspended <b>38 days after</b> the first confirmed case, while they were suspended throughout the country <b>43 days after</b> the first confirmed case.
ISRAEL	On March 12, 2020, the decision was made <b>20 days after</b> the first confirmed case.
SWEDEN	<b>No decision was made to suspend such events.</b>
SWITZERLAND	The ban regarding the suspension of such events altogether was introduced on April 19, 2020, <b>54 days after</b> the first confirmed case.
ITALY	The decision was made <b>18 days after</b> the first confirmed case throughout the country.
CANADA	The decision was put into practice on March 17, 2020 ( <b>on the 52<sup>nd</sup> day of the pandemic</b> ) in the province of Ontario, on March 18, 2020 ( <b>on the 50<sup>th</sup> day of the pandemic</b> ) in the province of British Columbia and on March 22, 2020 ( <b>on the 24<sup>th</sup> day of the pandemic</b> ) in the province of Quebec.
PORTUGAL	Such events were suspended <b>16 days after</b> the first confirmed case by the state of emergency declared.
RUSSIA	Concert halls, theatres, museums, and cultural institutions were shut down as of March 16, 2020, <b>45 days after</b> the first confirmed case. Events were banned across the country on March 19, 2020, <b>48 days later</b> after the first confirmed case.

# International Comparison of Measures



### QUESTION

How many days after the first confirmed case did countries shut down museums and archaeological sites?



TURKEY	The decision was made on March 27, 2020, <b>16 days after</b> the first confirmed case.
USA	There is no general arrangement. The decision in this direction is made individually by museums and state authorities.
GERMANY	The decision was introduced on March 23, 2020, <b>55 days after</b> the first confirmed case.
BELGIUM	The decision was made <b>40 days after</b> the first confirmed case, with effect from March 14, 2020.
BRAZIL	Such a decision was made <b>19 days after</b> the first confirmed case for the capital Brasília. Other states announced the decision much later.
CHINA	With the quarantine imposed in Wuhan on January 23, 2020, the mentioned areas were also closed.
FRANCE	The decision was introduced <b>50 days after</b> the first confirmed case.
SOUTH KOREA	Temporary closure of museums was announced on February 25, 2020, <b>36 days after</b> the first confirmed case.
THE NETHERLANDS	Museums were closed as of March 12, 2020, <b>13 days after</b> the first confirmed case.
UK	As of March 23, 2020, museums and archaeological sites were temporarily closed.
IRAN	The museums were closed <b>21 days after</b> the first confirmed case.



<b>SPAIN</b>	The mentioned premises were closed <b>41 days after</b> the first c case.
<b>ISRAEL</b>	A relevant decision was made on March 17, 2020, <b>25 days after</b> the first confirmed case.
<b>SWEDEN</b>	Museums and archaeological sites were closed on March 20, 2020, <b>49 days after</b> the first confirmed case. Open-air museums are not closed.
<b>SWITZERLAND</b>	The decision was introduced on April 19, 2020, <b>54 days after</b> the first confirmed case.
<b>ITALY</b>	The relevant decision was made <b>17 days after</b> the first confirmed case, taking effect throughout the country.
<b>CANADA</b>	Decisions were made on March 17, 2020 ( <b>on the 52<sup>nd</sup> day of the pandemic</b> ) in the province of Ontario, on March 18, 2020 ( <b>on the 50<sup>th</sup> day of the pandemic</b> ) in the province of British Columbia and March 22, 2020 ( <b>on the 24<sup>th</sup> day of the pandemic</b> ) in the province of Quebec.
<b>PORTUGAL</b>	The said premises were closed on the <b>16<sup>th</sup> day after</b> the first confirmed case by the state of emergency declared.
<b>RUSSIA</b>	They were closed as of March 16, 2020, <b>45 days after</b> the first confirmed case.

# International Comparison of Measures



## Measures for Picnic Areas

QUESTION	How many days after the first confirmed case did countries ban entry into areas such as national parks, forests, picnic areas due to coronavirus?
 <b>TURKEY</b>	On March 27, 2020, <b>16 days after</b> the first confirmed case, entry to these areas was banned.
<b>USA</b>	There is no restriction on entry into these areas throughout the country.
<b>GERMANY</b>	It was banned on March 23, 2020, <b>55 days after</b> the first confirmed case.
<b>BELGIUM</b>	<b>There is no ban on entry into these areas.</b>
<b>BRAZIL</b>	For the capital Brasília, the decision was made <b>23 days after</b> the first confirmed case. Other states announced their decisions much later.
<b>CHINA</b>	With the quarantine imposed in Wuhan on January 23, 2020, these areas were also closed. Later, they were subjected to restrictions and rules on the use of public areas, entertainment venues, and recreational areas throughout the country.
<b>FRANCE</b>	There is no consistent practice throughout the country, and these areas have been gradually closed to visit since March 17, 2020.
<b>SOUTH KOREA</b>	<b>Although the events to be held in these areas were cancelled in late February, a general ban was not been imposed.</b>
<b>THE NETHERLANDS</b>	As of March 23, 2020, <b>24 days after</b> the first confirmed case, it was decided that mayors would take necessary measures to disperse groups with more than 3 people, except for families, in areas such as parks, beaches, etc.
<b>UK</b>	Arrangements were made <b>50 days after</b> the first confirmed case. Parks in cities are only open for exercise. If they are overcrowded, they are temporarily closed. National parks, forests, and picnic areas are closed.



<b>IRAN</b>	Although there is no consistent practice across the country regarding entry into areas such as national parks, forests, picnic areas, entry into such areas in the capital Tehran was banned <b>35 days after</b> the first confirmed case.
<b>SPAIN</b>	Arrangements were made <b>43 days after</b> the first confirmed case.
<b>ISRAEL</b>	Decisions were made as of March 17, 2020, <b>25 days after</b> the first confirmed case.
<b>SWEDEN</b>	<b>It was not banned to visit areas such as national parks, forests, picnic areas.</b>
<b>SWITZERLAND</b>	Arrangements were made on April 19, 2020, <b>54 days after</b> the first confirmed case. <b>There is no restriction on entry into forests.</b>
<b>ITALY</b>	Measures were taken through the decision of the Ministry of Health issued on March 20, 2020, <b>29 days after</b> the first confirmed case.
<b>CANADA</b>	A federal decision was made on March 18, 2020, <b>53 days after</b> the first confirmed case.
<b>PORTUGAL</b>	A ban was imposed on the <b>16<sup>th</sup> day after</b> the first confirmed case by the state of emergency declared.
<b>RUSSIA</b>	A nationwide arrangement was not introduced. The initiative was given to administrative districts. As of March 28, 2020, <b>57 days after</b> the first confirmed case, parks were closed in Moscow.

# International Comparison of Measures



## Measures for Sports Events

QUESTION	How many days after the first confirmed case did countries postpone sports events (football, basketball, volleyball, etc.) in the leagues?
 <b>TURKEY</b>	On March 12, 2020, only <b>1 day after</b> the first confirmed case, it was decided to play all sports events without spectators. On March 19, 2020, the leagues were suspended indefinitely.
<b>USA</b>	On March 11, 2020, NBA announced the suspension of basketball competitions, while on March 12, 2020, the baseball, hockey, and football leagues announced the postponement of competitions.
<b>GERMANY</b>	Sports events were postponed as of 13 March 2020, <b>45 days after</b> the first confirmed case.
<b>BELGIUM</b>	The decision was made <b>40 days after</b> the first confirmed case, with effect from March 14, 2020.
<b>BRAZIL</b>	The decision on postponement was announced <b>19 days after</b> the first confirmed case.
<b>CHINA</b>	A postponement decision was made <b>50 days after</b> the first confirmed case.
<b>FRANCE</b>	A postponement decision was made <b>50 days after</b> the first confirmed case.
<b>SOUTH KOREA</b>	The postponement of the football league was announced on February 24, 2020, <b>35 days after</b> the first confirmed case; postponements in other leagues followed that decision.
<b>THE NETHERLANDS</b>	Sports events were cancelled as of March 12, 2020, <b>13 days after</b> the first confirmed case.
<b>UK</b>	The said decisions were made gradually approximately <b>30-40 days after</b> the first confirmed case. Professional football, including the Premier League, was postponed on March 13, 2020.
<b>IRAN</b>	Sports events were suspended <b>11 days after</b> the first confirmed case.

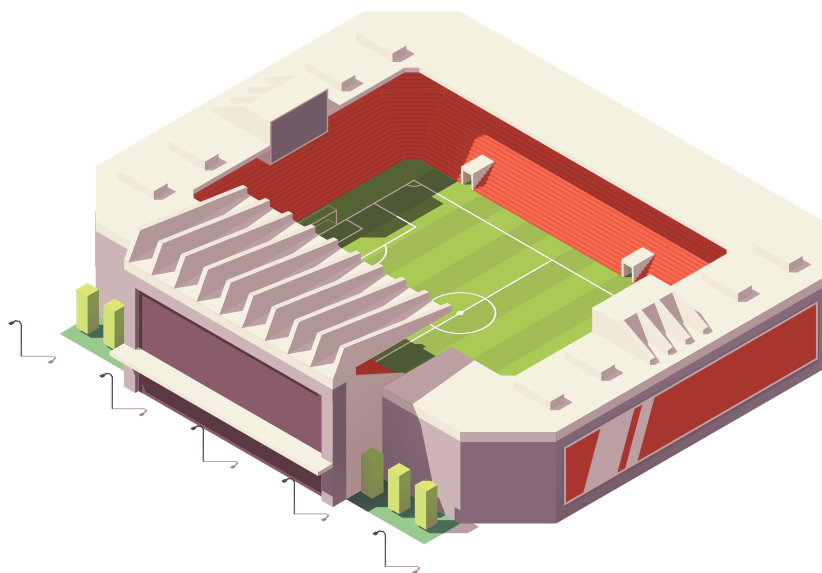

SPAIN	A postponement decision was made <b>41 days after</b> the first confirmed case.
ISRAEL	A relevant decision was made on March 12, 2020, <b>20 days after</b> the first confirmed case.
SWEDEN	Matches without spectators began on March 12, 2020, <b>41 days after</b> the first confirmed case. On March 29, 2020, 58 days after the first confirmed case, matches were suspended.
SWITZERLAND	On March 2, 2020, 3 days after the first confirmed case, a decision was made concerning football leagues. All sports competitions and events were postponed on April 19, 2020, <b>54 days after</b> the first confirmed case.
ITALY	It was decided to suspend all professional leagues <b>18 days after</b> the first confirmed case.
CANADA	National leagues were suspended as of March 13, 2020, the <b>48<sup>th</sup> day after</b> the first confirmed case.
PORTUGAL	Sports events were postponed on the <b>16<sup>th</sup> day after</b> the first confirmed case by the state of emergency declared.
RUSYA	The decision was introduced as of March 21, <b>50 days after</b> the first confirmed case.

## International Comparison of Measures



Number of  
Healthcare  
Professionals

QUESTION	How many days after the first confirmed case did countries take an initiative to increase the number of healthcare professionals?
 <b>TURKEY</b>	On March 23, 2020, <b>12 days after</b> the first confirmed case, such a decision was made.
<b>USA</b>	On March 18, 2020, the Department of Health and Human Services ceased to enforce the regulation stipulating that healthcare professionals should work only in the states where they are registered. On March 27, 2020, President Trump signed the Executive Order which allowed the recall of inactive military personnel to active duty. Foreign medical professionals wishing to work in the USA and those who take part in the fight against COVID-19, in particular, are encouraged to apply for a visa.
<b>GERMANY</b>	Although there is no arrangement for the recruitment of new personnel, medical school seniors provide support for healthcare services.
<b>BELGIUM</b>	On March 8, 2020, <b>34 days after</b> the first confirmed case, the Flemish Government called on retired doctors to work for the administrative departments of hospitals.
<b>BRAZIL</b>	Efforts to increase the number of healthcare professionals began <b>37 days after</b> the first confirmed case.
<b>CHINA</b>	<b>There is no information on such an initiative.</b>
<b>FRANCE</b>	A call was made to volunteers, <b>61 days after</b> the first confirmed case.
<b>SOUTH KOREA</b>	South Korea declared the cities of Daegu, Cheongdo, and Gyeongsan, where the disease was prevalent, a "special care zone", and then a "special disaster zone" before March. In this framework, additional resources were transferred and healthcare professionals were sent to the region. In addition, health volunteers from all over the country went to the city of Daegu to work.
<b>THE NETHERLANDS</b>	On March 18, 2020, <b>19 days after</b> the first confirmed case, a call was made to retired healthcare professionals to return to work during this period if they wish to do so.



## International Comparison of Measures

<b>UK</b>	On March 20, 2020, the National Health Service (NHS) sent a letter to retired healthcare professionals asking them to return to work.
<b>IRAN</b>	No initiative was taken to increase the number of healthcare professionals.
<b>SPAIN</b>	Initiatives to increase the number of healthcare professionals began <b>44 days after</b> the first confirmed case.
<b>ISRAEL</b>	There is no information on such an initiative.
<b>SWEDEN</b>	On March 20, 2020, <b>49 days after</b> the first confirmed case, those with experience in the health sector and students studying in the field of medicine were asked to become volunteers for the Stockholm county to combat the pandemic.
<b>SWITZERLAND</b>	There was no initiative to increase the number of healthcare professionals throughout the country.
<b>ITALY</b>	A budget was allocated for new healthcare professionals by the Decree "Cura Italia" adopted on March 16, 2020, <b>25 days after</b> the first confirmed case.
<b>CANADA</b>	The provincial government of Ontario made the first call on March 17, 2020 ( <b>on the 52<sup>nd</sup> day of the pandemic</b> ), and on March 14, 2020 ( <b>on the 46<sup>th</sup> day of the pandemic</b> ) "College of Physicians and Surgeons of British Columbia" called on healthcare professionals, who were retired in the past two years, to return to work. In the province of Quebec, with the emergency health situation introduced on March 13, 2020 ( <b>on the 15<sup>th</sup> day of the pandemic</b> ), arrangements were made to increase the number of healthcare professionals, especially nurses.
<b>PORTUGAL</b>	<b>10 days after</b> the first confirmed case, retired physicians, nurses, and healthcare professionals were called for duty on March 12, 2020.
<b>RUSSIA</b>	As of April 3, 2020, 700 interns started to work in Moscow's outpatient clinics <b>64 days after</b> the first confirmed case. On April 6, 2020, <b>68 days after</b> the first confirmed case, 118 interns began to work for outpatient clinics and hospitals in the Moscow Region.

# International Comparison of Measures



## Distribution of Medical Masks

QUESTION	Are medical masks distributed free of charge by the state in the country?	
 <b>TURKEY</b>	Masks are distributed free of charge in Turkey.	
<b>USA</b>	Masks are not distributed free of charge.	
<b>GERMANY</b>	Masks are not distributed free of charge.	
<b>BELGIUM</b>	There is no free distribution of masks by the state to citizens. The limited number of masks in stock is reserved for healthcare professionals.	
<b>BRAZIL</b>	Masks are not distributed free of charge.	
<b>CHINA</b>	There is no information on the free distribution of masks.	
<b>FRANCE</b>	Masks are not distributed free of charge.	
<b>SOUTH KOREA</b>	Masks are not distributed free of charge.	
<b>THE NETHERLANDS</b>	The use of masks in daily life depends on individual choice and it is observed that the masks are only worn exceptionally. For example, those who work for food delivery services use masks.	
<b>UK</b>	Masks are not distributed free of charge.	
<b>IRAN</b>	Masks are not distributed free of charge.	



<b>SPAIN</b>	Masks are not distributed free of charge.
<b>ISRAEL</b>	Masks are not distributed free of charge.
<b>SWEDEN</b>	Masks are not distributed free of charge.
<b>SWITZERLAND</b>	Masks are not distributed free of charge.
<b>ITALY</b>	There are different practices across regions. For example, the Tuscany Region announced that it would distribute 8.5 million masks to the public free of charge through municipalities.
<b>CANADA</b>	Masks are not distributed free of charge.
<b>PORTUGAL</b>	Masks are not distributed free of charge.
<b>RUSSIA</b>	Masks are not distributed free of charge.

# International Comparison of Measures



## Measures for Prisons

<b>QUESTION</b>	<b>How many days after the first confirmed case did countries postpone prison visits and prison transfers, etc.?</b>
 <b>TURKEY</b>	On March 12, 2020, only <b>1 day after</b> the first confirmed case, the permissions were postponed.
<b>USA</b>	These restrictions were imposed on federal prisons as of March 13, 2020.
<b>GERMANY</b>	There was a postponement on March 18, 2020, <b>50 days after</b> the first confirmed case.
<b>BELGIUM</b>	A step was taken in this direction <b>40 days after</b> the first confirmed case, with effect from March 14, 2020.
<b>BRAZIL</b>	<b>20 days after</b> the first confirmed case, prison visits were indefinitely postponed at the federal level.
<b>CHINA</b>	The National Health Commission announced necessary measures for prisons with the recommendations issued on March 1, 2020. Within this framework, it was recommended to postpone personnel visits. According to this arrangement, visits by prisoners' families were not banned. There is no arrangement to postpone releases or transfers between the prisons.
<b>FRANCE</b>	Such decisions were made <b>54 days after</b> the first confirmed case.
<b>SOUTH KOREA</b>	As of February 24, 2020, <b>35 days after</b> the first confirmed case, prison visits and prison transfers were postponed.
<b>THE NETHERLANDS</b>	It is understood that necessary measures have been taken to ensure that the pandemic does not spread in prisons.
<b>UK</b>	Various precautions were taken regarding the operation of prisons due to the coronavirus as of March 13, 2020. Within this framework, prison visits were suspended in the UK and Wales on March 24, 2020.



<b>IRAN</b>	Any activity that requires gathering in prisons was suspended <b>9 days after</b> the first confirmed case.
<b>SPAIN</b>	Initiatives were taken for prisons <b>44 days after</b> the first confirmed case.
<b>ISRAEL</b>	The relevant steps were taken on March 17, 2020, <b>25 days after</b> the first confirmed case.
<b>SWEDEN</b>	On March 12, 2020, <b>41 days after</b> the first confirmed case, restrictions were imposed on visiting prisoners and convicts. Within this framework, while lawyers, prosecutors, police officers, and other public officials, who have no symptoms of the virus, are allowed to visit prisons, others are not allowed to visit prisoners and convicts.
<b>SWITZERLAND</b>	<b>There is no restriction on this issue.</b>
<b>ITALY</b>	Arrangements for prisons were made <b>18 days after</b> the first confirmed case.
<b>CANADA</b>	On March 13, 2020, the <b>48<sup>th</sup> day</b> after the first confirmed case, Correctional Service Canada called on the family members of prisoners/convicts to postpone their prison visits.
<b>PORTUGAL</b>	Prison visits and transfers were suspended <b>16 days after</b> the first confirmed case by the state of emergency declared.
<b>RUSSIA</b>	As of March 24, 2020, <b>53 days after</b> the first confirmed case, such initiatives were taken.

# International Comparison of Measures



## Measures for District Bazaars

<b>QUESTION</b>	<b>How many days after the first confirmed case did countries make an arrangement/decision for district bazaars and supermarkets?</b>
 <b>TURKEY</b>	On March 24, 2020, <b>9 days after</b> the first confirmed case, decisions on supermarkets were made. In addition, arrangements concerning district bazaars were made on March 27, 2020, and April 1, 2020.
<b>USA</b>	There is no general arrangement for supermarkets. The states can decide to shut down places such as fresh fruit and vegetable markets.
<b>GERMANY</b>	People were prohibited from approaching each other more than 1.5 meters due to the physical social contact restriction introduced on March 23, 2020, <b>55 days after</b> the first confirmed case.
<b>BELGIUM</b>	Such a measure was taken on March 18, 2020, <b>44 days after</b> the first confirmed case.
<b>BRAZIL</b>	While the bazaars were shut down in the capital Brasília <b>23 days after</b> the first confirmed case, no arrangement was made for supermarkets. Other states made such decisions later.
<b>CHINA</b>	There was no such practice as the closure of bazaars or supermarkets in other provinces than the city of Wuhan and Hubei province, where the curfew was imposed.
<b>FRANCE</b>	Open-air bazaars were shut down <b>59 days after</b> the first confirmed case. Some markets can now be opened between certain hours with special permission, provided that strict measures of hygiene are followed.
<b>SOUTH KOREA</b>	No special arrangements were made for district bazaars and supermarkets, and some bazaars and shopping centres were temporarily shut down by their own decisions.
<b>THE NETHERLANDS</b>	District bazaars and supermarkets remain open. There are restrictions as to the number of customers and a social distance rule of 1.5 meters. Mask use is not obligatory.



<b>UK</b>	No arrangements were made for district bazaars and supermarkets, and markets started to take precautions for maintaining the social distance between customers within the market following Prime Minister Johnson's statement on March 16, 2020.
<b>IRAN</b>	There is no arrangement for district bazaars and supermarkets in Iran.
<b>SPAIN</b>	<b>44 days after</b> the first confirmed case, working hours and procedures of bazaars/ supermarkets (the number of people to be allowed inside at the same time, maintaining a distance between the people in queues, use of gloves, and anti-bacterial gel at the entrance and exit) were rearranged.
<b>ISRAEL</b>	Such arrangements were made on March 22, 2020, <b>30 days after</b> the first confirmed case.
<b>SWEDEN</b>	No special arrangements were made for district bazaars and supermarkets.
<b>SWITZERLAND</b>	On April 19, 2020, <b>54 days after</b> the first confirmed case, arrangements were made only for bazaars.
<b>ITALY</b>	Decisions were made in this regard <b>18 days after</b> the first confirmed case.
<b>CANADA</b>	The shopping centres providing essential foodstuff continue their activities. Announcements are made to follow the rules of physical distance while shopping, there is regular disinfection, and online shopping is preferred.
<b>PORTUGAL</b>	Relevant decisions were made <b>16 days after</b> the first confirmed case as part of the state of emergency declared.
<b>RUSSIA</b>	As of March 28, 2020, <b>57 days after</b> the first confirmed case, stores, shopping malls, and supermarkets were shut down with a nationwide suspension, except for pharmacies, and stores selling food and basic necessities.



**WE WILL SUCCEED TOGETHER**

# We will Succeed Together

The world is faced with a new crisis that it has to tackle in cooperation. In countries caught unprepared for the global pandemic, the number of deaths has reached calamitous levels. In many countries that we consider as developed countries, the size of the pandemic has caused much more damage than expected. In these countries, hospitals remain incapable and there are no masks available even for healthcare professionals. Tent hospitals have been established in the most famous cities of the world.

The world economy is going through a challenging period with the effect of these events. Experts call this period the biggest humanitarian crisis that has occurred since World War II.

Turkey takes the lead among few other countries which have taken the pandemic seriously since the first outbreak and before the first confirmed case in our country. Turkey has been putting up a successful fight against the most serious health crisis of modern times thanks to many improvements in the healthcare infrastructure, new and well-equipped hospitals as well as doctors and other healthcare professionals from 2002 up to today. With its robust healthcare system, Turkey is in a much better position than other developed countries and also has great advantages. Turkey enjoys a high capacity in many fields particularly in the number of beds, the number of intensive care beds as well as ventilators that are used in the treatment of the disease and other medical supplies. In fact, the Republic of Turkey has even sent aids to nearly 150 countries, mainly the European countries in which the pandemic has caused substantial losses and the healthcare infrastructure has collapsed.



**Thanks to many improvements in the healthcare infrastructure, new and well-equipped hospitals as well as doctors and other healthcare professionals from 2002 up to today, Turkey is ready to tackle this most serious health crisis of modern times. With its robust healthcare system, Turkey is in a much better position than other developed countries and has great advantages.**

## We Will Succeed Together

With the confidence offered by our strong healthcare system, the government officials, especially President Recep Tayyip Erdogan, take effective measures to manage the pandemic crisis and announce support packages covering all areas of life.

**Since the first days of the global pandemic, the Scientific Board consisting of experts, physicians, healthcare professionals, and academics has been established and the pandemic crisis has been handled with a scientific perspective. All recommendations of the Scientific Board are swiftly implemented by the Presidency and all courageous steps are taken without hesitation.**

A system that prioritizes human life and mobilizes all opportunities towards this end has been established and all ministries and public institutions have acted in coordination. Decision-making processes are carried out very quickly, which provides an important advantage against the pandemic that spreads rapidly.

**Responsibility campaigns such as "Stay Home" and "National Solidarity Campaign" have been launched by President Erdoğan himself and rapid results have been achieved thanks to strong leadership. The process has been carried out in line with the full transparency principle. The most important evidence of this understanding is the announcement of the number of cases, deaths, and tests to the public on a daily basis and also the launch of a website on the aid campaign.**

Turkey does not consider this understanding of mobilization at the national level, but it has been exerting substantial global efforts in the fight against the pandemic





**Together with its nation, the state has succeeded in overcoming every major problem it has faced up to now.** Finally, with the solidarity campaign launched by President Recep Tayyip Erdoğan with the call "We are Self-Sufficient," the whole country has mobilized to support all the groups adversely affected by the process.



from the very beginning. It plays a leading role in information sharing processes; and conducts a transparent and two-way communication process with countries and international organizations. To date, with an understanding of the global fight against coronavirus, the needs of countries requesting medical equipment and supplies from Turkey have been addressed largely and urgently.

This process, which requires the common struggle of the world, will be overcome by consciously applying the policies of all countries based upon the spirit of global unity.

Turkey will also overcome this problem and emerge stronger from this process. As President Recep Tayyip Erdoğan has stated, a new era has begun with the possibility of radical changes in the global, economic, political, and social order. Turkey will quickly take the steps required by this new era by making no concessions on international cooperation and continue to have a voice in its region and the world.

Today, we wish God's mercy upon those who have lost their lives in Turkey and throughout the world and offer our condolences to their families and loved ones and we also thank all healthcare professionals for their outstanding efforts.

**TURKEY'S  
EFFECTIVE FIGHT  
AGAINST CORONAVIRUS**



**TURKEY'S  
EFFECTIVE FIGHT  
AGAINST CORONAVIRUS**



**TURKEY'S  
EFFECTIVE FIGHT  
AGAINST CORONAVIRUS**



**TURKEY'S  
EFFECTIVE FIGHT  
AGAINST CORONAVIRUS**



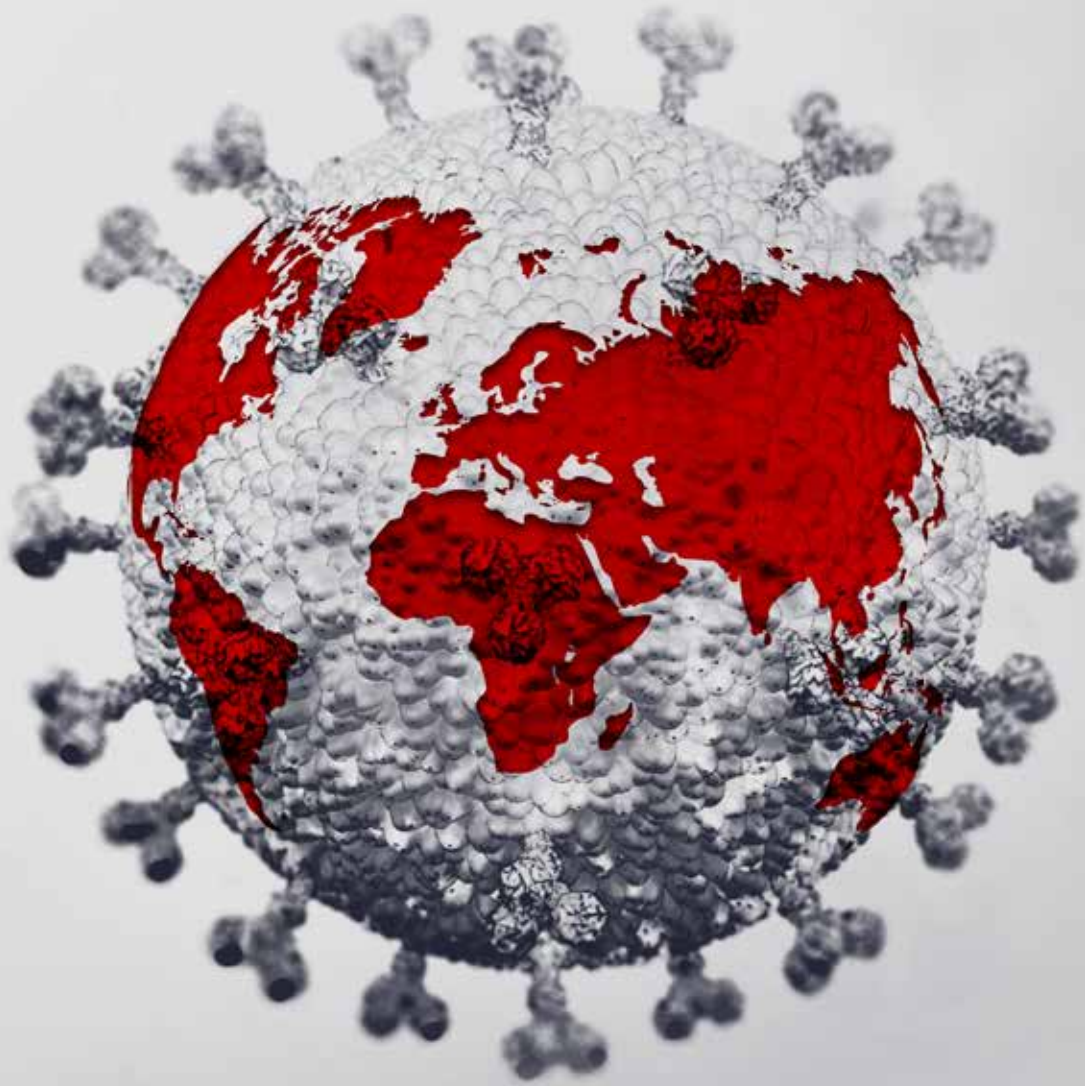

**TURKEY'S  
EFFECTIVE FIGHT  
AGAINST  
CORONAVIRUS**



ISBN: 978-605-06504-1-9



9 786050 650419